



# **TDMA WALKABOUT<sup>TM</sup> Operator's Manual**



## Table of Contents

General Information .....	vii
Copyright .....	vii
Software License Notice.....	vii
Trademark Acknowledgments.....	vii
About This Manual.....	vii
Computer Requirements.....	vii
Specifications .....	viii
Contacting SAFCO Technologies, Inc. ....	ix
Regional Offices.....	ix
The SAFCO Web Site (www.safco.com) .....	x
Warranty Information.....	xi
Warranty Service .....	xi
Repair and Return Procedure .....	xi
Special Notes .....	xii
<b>Getting Started.....</b>	<b>1</b>
Introduction .....	1
Installation Tasks .....	1
Software Operation Tasks.....	1
Installing the WALKABOUT Software .....	2
General Installation Instructions .....	2
After Loading the Software.....	2
The Next Step.....	2
<b>Chapter 1 — Portable System Installation.....</b>	<b>3</b>
Introduction .....	3
Portable System Parts List .....	3
Installing the WALKABOUT Battery.....	3
Charging the WALKABOUT Battery.....	4
Internal Charging.....	4
External Charging.....	4
Charging the Computer and Phone Batteries.....	4
Portable System Cable Connections .....	5
Portable System Diagrams .....	5
In-Vehicle WALKABOUT Installation .....	7
Stand-Alone Mounting Plate Installation .....	7
Mounting Plate Installed With Other Units.....	7
Attaching the WALKABOUT to the Mounting Plate.....	8
Power Cable .....	8
Data Cable .....	8
Audio Monitoring Kit .....	9
Optional Navigators .....	10
ETAK GPS PCMCIA Card.....	10
Garmin GPS II Plus .....	10

---

Navigator Plus.....	10
Clarion Navigator .....	10
Powering Up the System.....	11
Portable System .....	11
In-vehicle System.....	11
WALKABOUT CPU LED .....	11
Removing and Replacing Phones .....	11
The Next Step.....	12
<b>Chapter 2 — The WALKABOUT Software Display .....</b>	<b>13</b>
Introduction .....	13
Starting the WALKABOUT Software .....	13
Display Features.....	14
Main Toolbar.....	14
Menus .....	15
Time Bar .....	16
Status Bar.....	17
Using Online Help.....	18
The Next Step.....	19
<b>Chapter 3 — Device Selection .....</b>	<b>21</b>
Introduction.....	21
Identify the Tracking Phone and Scanner .....	21
Identify the Navigator .....	22
Enable the Devices .....	22
Save the Configuration.....	23
Reviewing the Configuration.....	23
System Setup View Pop-up Menus .....	24
Com Port Pop-up Menu .....	24
WALKABOUT System Pop-up Menu .....	24
Tracker Pop-up Menu.....	25
Scanner Pop-up Menu .....	26
Navigator Pop-up Menu.....	26
The Next Step.....	26
<b>Chapter 4 — Views .....</b>	<b>27</b>
Introduction .....	27
DFI Selector View.....	27
IS136 CAI Messages View.....	28
Properties Dialog Box – IS136 CAI Messages View .....	29
IS136 Neighbor RSSI View.....	31
Cell Site Name .....	31
IS136 Neighbor Time View .....	32
IS136 Tracker View .....	33

---

Route Map View .....	35
Introduction .....	35
Route Map Buttons .....	36
Text Areas and Indicators .....	39
Configuring the Route Map .....	40
Map Picture Layer Properties .....	40
Street Maps Layer Properties .....	41
Signal Layer Properties .....	43
Cell Site Layer Properties .....	46
Current Position Layer Properties .....	48
Grid Layer Properties .....	48
Survey Marker Layer Properties .....	48
Scanner View .....	49
Configuring the Scanner View .....	50
Scanner Table View .....	54
Scanner Table View Pop-up Menu .....	54
Call Stats View .....	55
Grid View Options .....	55
Chart View Options .....	57
Carrier vs Interferer View .....	58
Options .....	58
Carrier vs Interferer Examples .....	58
Configuring the Carrier vs Interferer View .....	59
C/I List Tab .....	59
Axis Tab .....	60
Closing the Dialog box .....	60
Monitor Settings View .....	61
Examples of Alerts .....	61
Overview of Configuring an Alert .....	61
Configuring an Alert .....	62
Reconfiguring an Existing Alert .....	64
Time Chart View .....	65
Time Chart Properties .....	65
Data Tab .....	66
Chart Tab .....	68
Color Tab .....	68
Font Tab .....	68
Closing the Time Chart Properties Dialog Box .....	69
Selecting Multiple Views .....	69
Adding a View .....	69
Removing a View .....	69
Navigation View .....	70
MultiMode Navigation Properties .....	70
Options Dialog Box .....	71
Survey Markers Tab .....	71
Cable Connection Tab .....	72

---

---

Battery Tab.....	73
Cell Site Database Tab.....	74
View Setup Tab.....	74
TQNM Tab.....	74
The Next Step.....	75
<b>Chapter 5 — Device Configuration.....</b>	<b>77</b>
Introduction.....	77
Properties Dialog Box.....	77
Configuring the TDMA (IS-136) Tracker.....	78
Param Mask Tab.....	78
Parameters Tab.....	79
Enable Mask Tab.....	79
Auto Dialling Tab.....	79
Saving Properties.....	80
Configuring the Scanner.....	81
Data Mode Tab.....	81
Scanner Channel Tab.....	82
Using Custom Scan Lists.....	83
RF Recording Tab.....	83
Saving Properties.....	83
Using Multiple Test Plans.....	84
Creating a New .SPF File.....	84
Opening an .SPF File.....	84
Editing a Scan List.....	85
Opening an Existing *.cpf File in Excel.....	85
Editing the File.....	85
Saving the Edited File.....	85
Creating a Scan List.....	86
Saving the File.....	86
The Next Step.....	86
<b>Chapter 6 — Data Collection.....</b>	<b>87</b>
Survey Types.....	87
Status Bar.....	87
Battery Icon.....	87
Signal Status.....	87
Performing an In-building Survey.....	88
Introduction.....	88
Enabling Layers in the Route Map.....	88
Performing the Test.....	89
Pausing and Resuming Data Collection.....	90
User Notes.....	90
Survey Markers.....	90
Post Processing.....	90

---

Performing a Paced Mode Survey .....	91
Introduction.....	91
Enabling Layers in the Route Map.....	91
Performing the Test.....	92
User Notes .....	93
Survey Markers.....	93
Post Processing.....	93
Performing an In-Vehicle Survey.....	94
Introduction.....	94
Enabling Layers in the Route Map.....	95
Performing the Test.....	96
User Notes .....	96
Survey Markers.....	96
Post Processing.....	97
Replaying a Data File .....	97
Replaying Data During a Survey.....	97
Replaying the From the Current Survey.....	97
Replaying a Data File from a Previous Survey.....	97
Main Toolbar Buttons — Playback Mode.....	98
Exporting a Data File .....	99
About MapInfo Files.....	99
Exiting the WALKABOUT Software .....	99
Powering the System Down.....	99
<b>Appendix A — FAQs .....</b>	<b>101</b>
Frequently Asked Questions .....	101
<b>Index.....</b>	<b>103</b>





---

## General Information

### Copyright

Copyright SAFCO Technologies, Inc., 2000. All rights reserved. No part of this publication may be reproduced, transmitted, transcribed, stored in a retrieval system, or translated into any language in any form by any means without the written permission of SAFCO Technologies, Inc.

### Software License Notice

Your License Agreement with SAFCO Technologies, Inc. that is included with the WALKABOUT system specifies the permitted and prohibited uses of the product. Any unauthorized duplication or use of SAFCO Technologies software in whole or in part, in print, or in any other storage and retrieval system is forbidden.

### Trademark Acknowledgments

- SAFCO is a registered trademark of SAFCO Technologies, Inc.
- WALKABOUT and OPAS32 are trademarks of SAFCO Technologies, Inc.
- Windows is a trademark and Microsoft is a registered trademark of Microsoft Corporation.
- All other trademarks are the property of their respective holders.

### About This Manual

This manual contains instructions for operating the TDMA (IS-136) WALKABOUT system. It is to be used with systems equipped with WALKABOUT data collection software release 3.0 and later.

WALKABOUT software is compatible with Windows 95, 98, or NT 4.0, and is Year 2000 Compliant. Persons using this product should be familiar with Windows 95, 98, or NT 4.0.

Refer to one of the following SAFCO publications for in-vehicle installation instructions:

- WALKABOUT with Navigator Plus In-Vehicle Installation and Navigator Calibration
- WALKABOUT with Clarion™ Navigator In-Vehicle Installation and Navigator Operation
- Trimble Placer Installation and Calibration Manual for the WALKABOUT

### Computer Requirements

The following are the minimum requirements for the WALKABOUT system computer:

- 233 MHz Pentium processor
- 32 MB RAM (minimum)
- 1 serial port per test mobile
- 1 serial port for the navigation device (if equipped)
- 300 MB disk storage (minimum)
- Fujitsu Stylistic 2300 Pen-based computer (recommended platform)

**Specifications**

The following WALKABOUT specifications are subject to change without notice.

Operating Temperature Range	0° to +50° C (+32° to +122° F)
Storage Temperature Range	-20° to +60° C
Dimensions (approx.)	165mm x 130mm x 90mm 6.5 x 5.25 x 3.6 inches
Weight (without tracking phone)	6.4 lbs.
Power	
Voltage (battery charger)	100-240VAC @ 50-60 Hz
Battery life	2 Hrs Typical – Single Band Scanners 1 Hrs – Dual Band and PN Scanners

## Contacting SAFCO Technologies, Inc.

### Regional Offices

---

#### North American Operations

6060 Northwest Highway  
Chicago, IL 60631  
USA

Tel: + 1-800-544-1431 (Support - toll-free in the USA and  
Canada)

Tel: + 1-800-843-7558 (Reception - toll-free in the USA)  
+ 1-773-631-6216

Fax: + 1-773-631-1626

E-mail: support@safco.com

#### SAFCO Melbourne

(Customer training and support  
for *Wizard*® Software)

SAFCO Technologies, Inc.  
600 Atlantis Road  
Melbourne, FL 32904  
USA

Tel: + 1-321-952-8300

Fax: + 1-321-725-5062

E-mail: tecc@tecc.com

---

#### Caribbean and Latin American Operations

777 West Yamato Road  
Suite 130  
Boca Raton, FL 33431  
USA

Tel: + 1-561-241-8835

Fax: + 1-561-998-4293

E-mail: Cala\_support@safco.com

#### Brazil Operations

Av. Brig. Faria  
Lima No. 1306 - 5° Andar  
Sao Paulo - SP - 01452-000  
Brazil

Tel: + 5511-3067-4610

Fax: + 5511-3067-4554

E-mail:

Brazil\_support@safco.com

#### ComOpt and Europe, Africa & Middle East Operations

Michael Löfmans Gata 6  
SE-254 38 Helsingborg  
Sweden

Tel: + 46-42-21-25-80

Fax: + 46-42-21-05-85

E-mail: info@comopt.com

---

#### Asia Pacific Operations

16/F Flat B Chinaweal Centre  
414-424 Jaffe Road  
Wanchai,  
Hong Kong

Tel: + 852-2891-3603

Fax: + 852-2891-3515

E-mail: HK\_support@safco.com

#### China Branch

Room 1803  
Shanghai Kerry Centre  
1515 Nan Jing Road West  
Shanghai 200040  
P.R. China

Tel: + 86-21-5298-6806

+ 86-21-5298-6328

Fax: +86-21-5298-6807

E-mail:

China\_support@safco.com

#### India Branch

India Liaison Office  
Suite No. 203  
Chintels House A-11  
Kailash Colony  
New Delhi 110 048  
India

Tel: + 91-11-623-8620 to 29

Fax: + 91-11-647-7423

E-mail:

India\_support@safco.com

---

#### Japan Branch

Serie Building 5th Floor  
4-1 Kojimachi, Chiyoda-ku  
Tokyo 102-0083  
Japan

Tel: + 81-3-5215-5757

Fax: + 81-3-5215-5759

E-mail: Japan\_support@safco.com

#### Philippines Branch

# 2 Rapu-Rapu St.  
Tierra Nueva Village  
Alabang, Metro Manila  
Philippines

Tel: + 632-560-0295

Fax: + 632-560-0294

E-mail:

Philippines\_support@safco.com

#### Singapore

(Contact the Hong Kong office)

## **The SAFCO Web Site (www.safco.com)**

Visit our web site for the latest information on SAFCO products. In the Secure Client Services area, you can take advantage of support services such as an FAQ knowledge base, technical bulletins, operator's manuals, and software updates. An ID and password are required to access Secure Client Services.

### ***Getting a User ID and Password***

To obtain an ID and password to access our Secure Client Services, follow these steps:

1. Connect to the Internet, and open your browser.
2. Go to **www.safco.com**.
3. On the SAFCO Technologies home page, click on **Customer Support**.
4. On the SAFCO Support page, click on the **Secure Client Services** link under the Customer Support heading. (You can also replace steps 1 and 2 by entering the URL that gets you directly to the login for the secure area: [www.safco.com/support/secure.asp](http://www.safco.com/support/secure.asp).)
5. On the Secure Client Services page, click on the **Register** link. A short form is displayed for setting up an account.
6. Complete the form, then click the **Submit** button. Our Customer Support Group will send your approved User Name and password to you via e-mail.

### ***Using Secure Client Services***

To access Secure Client Services, follow these steps:

1. Follow steps 1 through 4 above.
2. On the Secure Client Services page, click on the **Login** link.
3. Type your user name and password in the Enter Network Password dialog box.
4. On The Customer Support – Secure Client Services page, click on **WALKABOUT**.
5. On the Customer Support – WALKABOUT page, choose one of the following links:
  - Click **Feedback** to send us comments or questions, or to be added to the WALKABOUT mailing list.
  - Click **FAQs** to find answers to common questions.
  - Click **Technical Documents** for a list of manuals, addenda, and technical bulletins that are available for download.
  - Click **File a Report** to tell us about a “bug” you have experienced.
  - Click **File Exchange** if a Customer Support Engineer has told you about an updated file that you need for your software.

---

## Warranty Information

Please refer to your Purchase Agreement for specific warranty information.

### Warranty Service

To arrange for warranty service, contact Customer Support at the appropriate office. You will need the serial number from the WALKABOUT system component to obtain a Return Material Authorization (RMA) number. Refer to the *Repair and Return Procedure* below for details.

## Repair and Return Procedure

The following procedure describes how to return a system component to SAFCO Technologies, Inc. for repair. This procedure is applicable to both in-warranty and out-of-warranty repairs.

1. Call your regional office, or call SAFCO Technologies main office. (Phone numbers are listed on page vii.) Describe the problem to the Customer Support engineer. Please have your product's serial number and date of purchase available. The engineer will issue you a Return Material Authorization (RMA) number.

If your unit is not covered by the warranty, you must provide the Customer Support engineer with a Purchase Order number, or include a Purchase Order with your unit when you return it. Purchase Orders will not be accepted for repairs valued under \$1000.00. Repair charges under \$1000.00 must be charged against a credit card, or paid in advance. The engineer will provide you with any further instructions, if necessary.

2. Pack the unit in its original container, a shipping case, or in a sturdy corrugated box using non-static foam padding as a cushion. Do not use highly static-prone material, such as plastic wrap or plastic packing material (beads or peanuts), as they may further damage the unit in transit.
3. Include the following information with your unit:
  - Company Name  
Address  
City, State Zip Code
  - Telephone Number
  - RMA Number (obtained from the Customer Support representative)
  - Description of the problem
  - Purchase order or number

4. Ship the unit, freight prepaid to:

SAFCO Technologies, Inc.  
6060 Northwest Highway  
Chicago, IL 60631

Attention: Repair Dept., RMA #

5. The repaired or replacement unit will be shipped to and from SAFCO Technologies, Inc. per the following schedule:
  - A. Warranty Customers: SAFCO will pay shipping charges both "from" and "to" the customer site.

- B. Support Contract Customers: Please check the terms of your contract in the section entitled "PACKING AND SHIPPING".
- C. All Other Customers: The customer will pay for shipping charges both "to" and "from" SAFCO.

### **Special Notes**

- All items must be packaged sufficiently to prevent damage during shipment. Whenever possible, original shipping containers must be used for returns to SAFCO.
- SAFCO Technologies recommends that you insure the unit when it is shipped. SAFCO will not accept units shipped C.O.D.
- Unless given specific instructions by the customer, SAFCO will select appropriate shipping methods.

# Getting Started

## Introduction

This manual contains all of the instructions you will need to operate your WALKABOUT system. A glossary of terms can be found in the data collection software's online Help. If you have purchased a navigator for an in-vehicle installation, refer to the navigator installation manual for in-vehicle cable connection instructions.

The following tables list the tasks you will need to complete before you perform the first data collection test.

### Installation Tasks

Task	See Page
Install the Software. (If you have purchased a computer from SAFCO, the software has already been installed.)	2
Install and charge the batteries.	3
Connect the portable system cables. (Refer to the navigator manual for in-vehicle system cable connections.)	5
Power-up the system.	11
Start the WALKABOUT software.	13

### Software Operation Tasks

Task	See Chapter
Select the devices. In this step, the software identifies the tracking phone, scanner, and navigator (if equipped).	(Chapter 3)
Select the standard views for the display.	(Chapter 4)
Configure the user-configurable views.	(Chapter 4)
Configure the tracking phone and scanner properties.	(Chapter 5)
Choose a survey type. (This depends on the equipment ordered.)	(Chapter 6)
Perform the test.	(Chapter 6)

## Installing the WALKABOUT Software

This section is provided for customers who are installing the data collection software. If your system was delivered with a computer and the software has been installed, please proceed to *Chapter 1 — Portable System Installation*.

### General Installation Instructions

1. Insert the installation CD into the CD-ROM drive, or insert Disk 1 of the floppy disk set into the floppy drive.
2. Using Windows Explorer, locate the program name SETUP.EXE, then double click on it to start the installation program.
3. Follow the instructions in the Installation Wizard. We recommend that you accept the defaults that are given for the Destination Directory and Program Folder.
4. If you are using floppy disks, insert each disk as you are prompted for it.
5. After the installation program completes, click the **OK** button in the Restarting Windows dialog box to restart the computer.

### After Loading the Software

- If you plan to use in-building navigation with a bitmap image of the survey area or floor plan, or plan to use a map file with an in-vehicle navigator, we recommend that you create a Maps folder within the WALKABOUT directory, then copy the bitmap into the Maps folder.
- Create a Data folder for storing the data files. Data files have the “.sd5” extension. When you begin a survey, you are presented with a dialog box, asking for a file name and a location in which to store the data file.

## The Next Step

Refer to *Chapter 1 — Portable System Installation* for cable connection and battery charging information.



# Chapter 1 — Portable System Installation

## Introduction

This chapter contains the necessary information you will need to connect the cables of the portable WALKABOUT system. If your system includes a navigator, refer to the navigator installation manual included with your system for the in-vehicle installation instructions and parts list.

## Portable System Parts List

The following is a list of the portable system components and cables referred to in this chapter. (Some cables may not be labeled with part numbers.) Refer to the *Deliverable Items List* included with your system for part numbers not listed below.

Item	Part Number
Tracking phone interface cable	(Refer to the D.I.L.)
WALKABOUT data cable, 3 foot coiled (not labeled)	2037-719
Scanner antenna cable, 18"	2136-284
Scanner antenna cable, 36"	2136-285
Battery	2345-882
Battery cable with clip (connect this cable from the battery to the WALKABOUT)	2037-796
Battery charger	1892-117
Battery charger adapter cable (connect this cable to the battery when using the battery charger)	2037-803

## Installing the WALKABOUT Battery

The following procedure only applies to portable battery-powered WALKABOUT systems. Refer to the navigator installation manual for information about WALKABOUT power connections to the vehicle.

1. Unzip the battery compartment zipper.
2. Connect the battery cable with clip (p/n 2037-796) to the cable inside of the battery compartment (p/n 2083-749).
3. Connect the opposite end of the WALKABOUT battery cable with clip to the battery.
4. Insert the battery into the battery compartment.
5. Rezip the battery compartment zipper.

## Charging the WALKABOUT Battery

The following procedures only apply to portable battery-powered WALKABOUT systems. Always charge the battery before you begin a survey.

### Internal Charging

1. Press the **Off/On** (Off / On) Power switch of the WALKABOUT phone interface to turn the unit off.
2. Plug the battery charger cable into the **CHARGE** input of the WALKABOUT.
3. Plug the battery charger (p/n 1892-117) into an AC outlet.
4. While the battery is charging at a high rate, the red LED glows brightly, and the green LED is off.
5. When the battery is fully charged, the red LED will be dim or turn off, and the green LED will turn on, indicating a float charge.
6. Unplug the charger from the WALKABOUT and the AC power after the battery is charged.

### External Charging

#### *Removing the Battery*

1. Unzip the battery compartment zipper.
2. Remove the battery.
3. Remove the battery clip in the direction of the arrow on the battery.
4. Connect the battery clip adapter cable (p/n 2037-803) to the battery charger cable.
5. Connect the battery clip adapter cable to the battery.
6. Plug the battery charger (p/n 1892-117) into an AC outlet.
7. While the battery is charging at a high rate, the red LED glows brightly, and the green LED is off.
8. When the battery is fully charged, the red LED will be dim or turn off, and the green LED will turn on, indicating a float charge.
9. Unplug the charger from the AC power after the battery is charged.

#### *Replacing the Battery*

1. Remove the charger's battery clip in the direction of the arrow on the battery.
2. Connect the WALKABOUT battery cable with clip (p/n 2037-796) to the battery.
3. Insert the battery into the battery compartment.
4. Rezip the battery compartment zipper.



## Charging the Computer and Phone Batteries

Refer to the manufacturer's documentation for specific operating instructions on computers and phones. Before performing a data collection test, charge the batteries for the tracking phone and the computer.

## Portable System Cable Connections

This section contains instructions for connecting the cables for a portable system equipped with an IS-136 tracking phone, a SAFCO phone interface module, a scanner, and a laptop computer. Refer to the *Deliverable Items List* included with your system for cable part numbers not specified in the following text.

If your system is equipped with a navigator and is installed in a vehicle, refer to the installation manual included with your system for cable connection instructions.

1. Connect the phone interface cable to the IS-136 call tracking phone.
2. Connect the opposite end of the phone interface cable to the  or **PHONE 1** port of the SAFCO phone interface module.
3. Connect the antenna cable (p/n 2136-284 or 2136-285) to the clip-on antenna.
4. Connect the opposite end of the antenna cable to the **RF INPUT** connector on the side of the high speed scanner.
5. Connect the plug end of the coiled data cable (p/n 2037-719) to the  or **COM 1** Serial Data port of the phone interface module.
6. Connect the socket end of the coiled data cable to the Serial port of the computer.
7. Unzip the battery compartment of the carrying case. Connect the battery cable (p/n 2037-796) to the power adapter cable (p/n 2037-749) inside.
8. Connect the opposite end of the battery cable to the battery.

**Note:** Always use a fully charged battery.

9. Insert the battery into the carrying case, then rezip the zipper.

## Portable System Diagrams

Figure 1  
WALKABOUT Front Panel (Original Housing)

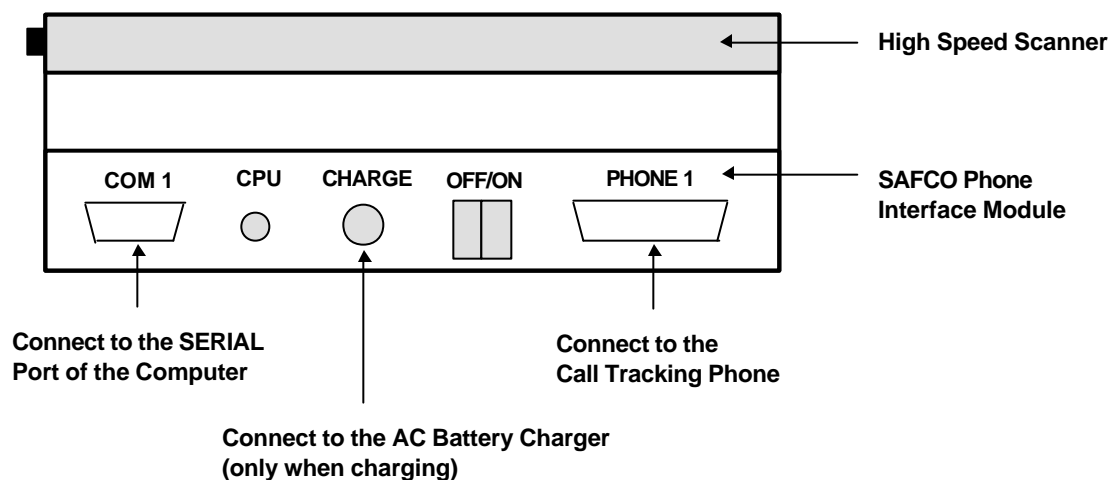

**Figure 2**  
WALKABOUT Front Panel (In-Vehicle Housing)

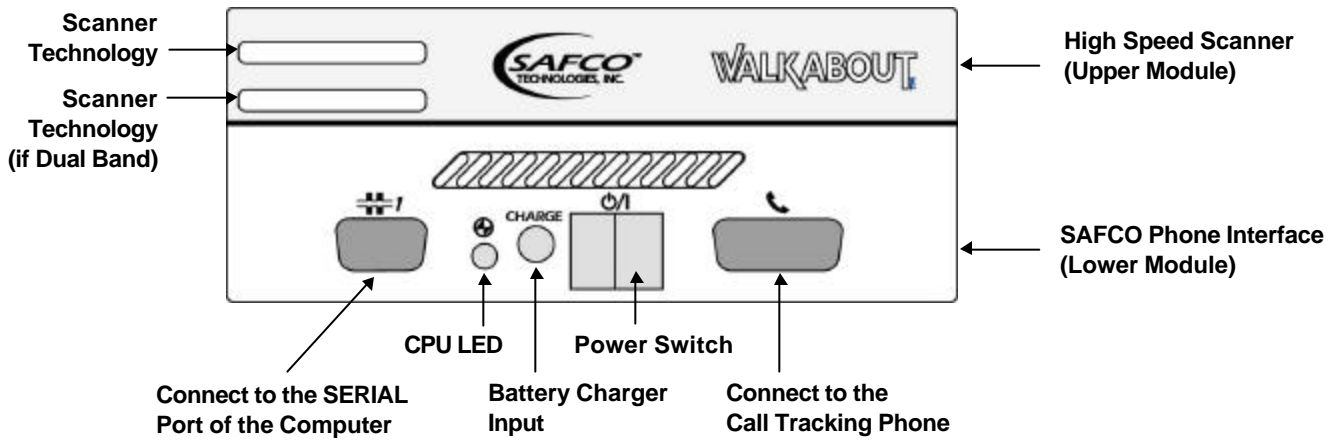

**Figure 3**  
WALKABOUT Side Panel

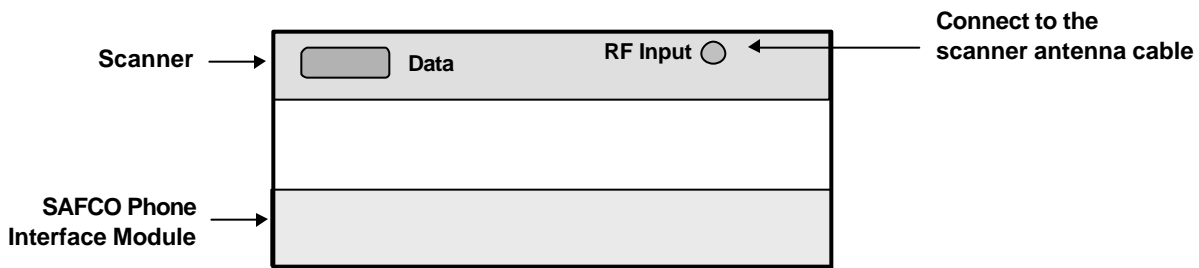

**Figure 4**  
Portable System Cable Connections (Battery powered)

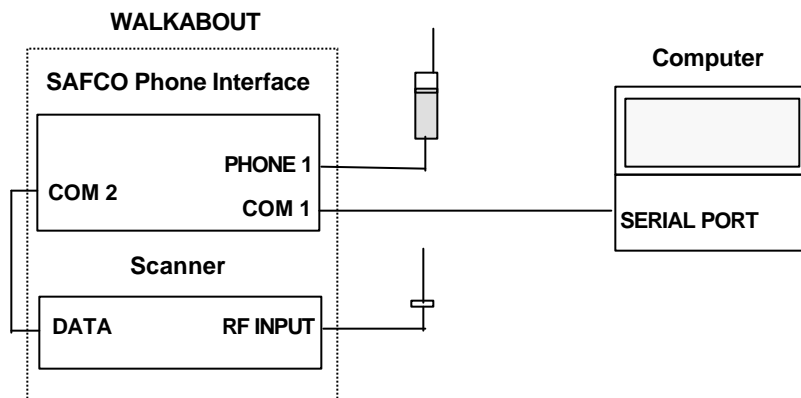

**Note:** For an in-vehicle system, refer to the navigator’s installation manual for specific cable connection instructions and diagrams.

## In-Vehicle WALKABOUT Installation

The following instructions are for installing a WALKABOUT system that does not include a navigator in a vehicle. If you are also installing a navigator, follow the installation instructions in the navigator manual included with the system.

The in-vehicle kit includes a mounting plate and may include an audio monitoring kit. The mounting plate must be attached securely to a flat surface of the vehicle. The WALKABOUT attaches to the mounting plate via tabs on the plate. A locking tab holds the WALKABOUT in place.

A separate instruction is included with the WALKABOUT in-vehicle housing upgrade. The instruction describes how to retrofit an older WALKABOUT with the new housing.

## Stand-Alone Mounting Plate Installation

The dimensions of the plate are approximately 12-1/8" wide by 11-1/4" front-to-back.

---

**Important!** Before drilling into the vehicle chassis, verify that you are not drilling into the fuel tank, a wiring harness, a brake line, or any other critical area.

---

1. Place the mounting plate in the desired location.
2. Mark the holes for the # 10 mounting screws on the mounting surface according to the hole pattern of the plate.
3. Drill the holes, using a 3/32" drill bit.
4. Attach the base plate to the vehicle, using the hardware provided.

**Figure 5**  
WALKABOUT on Mounting Plate

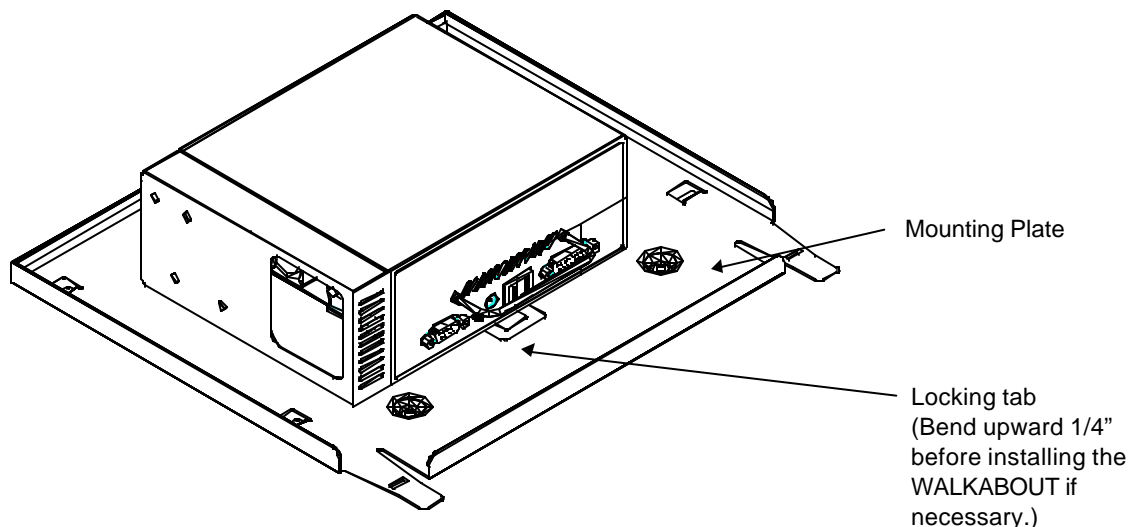

## Mounting Plate Installed With Other Units

The WALKABOUT mounting plate can be attached to the side brackets of a CarPak kit, that mounts a navigator or a Portable VoicePrint Integrated Controller. Insert the tabs of the mounting plate into the holes in the top surface of the side brackets, then slide the plate rearward to lock it in place.

The mounting plate can also be attached to the top of a Portable VoicePrint TransPak or MultiPak chassis. Align the mounting holes of the plate with the threaded holes of the chassis, then secure the plate with 8-32 screws.

---

### Attaching the WALKABOUT to the Mounting Plate

---

**Important!** Verify that the locking tab (shown on the previous page) protrudes at least 1/4" above the surface of the plate. Bend the tab upward if necessary.

---

1. Position the WALKABOUT on the mounting plate as shown on the previous page, with the tabs of the mounting plate passing through holes in the WALKABOUT.
2. Pull the WALKABOUT towards you until the locking tab snaps in place.
3. Verify that the WALKABOUT is securely mounted.

### Power Cable

1. Uncouple the 2-position battery connector, then remove the WALKABOUT battery.
2. Connect the power cable to the 2-position battery connector of the WALKABOUT.
3. Route the power cable through the vehicle.

---

**Note:** Connections to vehicle power will be covered in a future addendum.

---

### Data Cable

1. Connect one end of the data cable to the  Serial Data port of the WALKABOUT.
2. Route the cable through the vehicle.
3. Connect the opposite end to the Serial port of the computer.

## Audio Monitoring Kit

The audio monitoring option includes a phone cradle attached to an over-the-seat mounting bracket, an audio interface module, a speaker, an audio interface extender cable, and a phone interface cable. The cradle has a quick-release clamp that holds the phone in place. To release the phone, press the red button.

---

**Important!** The WALKABOUT phone interface and scanner are configured for specific technologies. If your system is equipped with two WALKABOUT units of different technologies, verify that the technology of the phone matches the WALKABOUT unit that you are connecting the extender cable to. Refer to the Deliverable Items List for the specific part numbers.

---

To connect the audio monitoring option, follow these steps:

1. Connect the phone to the phone interface cable.
2. Secure the phone within the cradle.
3. Connect the phone interface cable to the audio interface unit. (It may already be connected.)
4. Connect the speaker to the audio interface unit.
5. Connect the audio interface extender cable (p/n 2136-315) to the audio interface unit.
6. Mount the phone cradle assembly to the seat back.
7. Route the audio interface extender cable through the vehicle to where the WALKABOUT is mounted.
8. Connect the opposite end of the audio interface extender cable to the  Tracking Phone port of the WALKABOUT phone interface module.

---

**Important!** Two different phone interface cables are included with the system when the audio monitoring and pedestrian survey options are both ordered. The cables are not interchangeable. The cable included with the audio monitoring kit should not be used for pedestrian surveys. The separate 3 foot (approximately 1 meter) cable is to be used for pedestrian surveys, when the WALKABOUT is powered by its internal battery.

With the audio monitoring kit connected and the WALKABOUT powered on, the phone's battery charges via the audio monitoring components. Therefore, when using the audio monitoring option, the WALKABOUT must be powered by the in-vehicle power cable that is connected to the Clarion Navigator.

---

## Optional Navigators

### ETAK GPS PCMCIA Card

The WALKABOUT data collection software supports NMEA protocol. If you plan to use an ETAK GPS PCMCIA card for in-vehicle navigation, follow the manufacturer's instructions for installing the card. Move the selector switch on the card in the **NMEA** position.

After installation, the WALKABOUT software must be configured to identify the GPS card as the navigator. Refer to the *Identify the Navigator* section on page 22 for the procedure.

### Garmin GPS II Plus

The WALKABOUT data collection software supports this navigator. The Garmin GPS II Plus is used in an in-vehicle installation when only GPS navigation is required.

#### **Cable Connections**

A serial data / power cable is included with the Garmin GPS II Plus. If you plan to operate the unit using internal batteries, refer to the Garmin GPS II Plus operator's manual for battery installation instructions.

1. Connect the round connector of the cable to the GPS unit. Note that the connector is keyed.
2. Connect the DB-9 end of the cable to an available serial port of the computer.
3. Connect the power plug to the cigarette lighter socket.

#### **Garmin GPS II Operation and Configuration**

The Garmin GPS II Plus must be set to communicate in NMEA format. If the Garmin GPS was delivered with your system, then it has already been set up and tested. If it was purchased separately, refer to Technical Bulletin p/n 2083-259 for setup instructions. Refer to the Garmin GPS II Plus operator's manual for other configuration and operating instructions.

#### **Data Collection Software Configuration**

The data collection software must be configured to communicate with the Garmin GPS II Plus. Refer to the *Identify the Navigator* section on page 22 for the procedure.

### Navigator Plus

Refer to the *WALKABOUT with Navigator Plus In-Vehicle Installation and Navigator Calibration* manual for complete information.

### Clarion Navigator

Refer to the *WALKABOUT with Clarionä Navigator In-Vehicle Installation and Navigator Operation* manual for complete information.



## Powering Up the System

### Portable System

1. Press the **PWR** button on the tracking phone to turn it on.
2. Press the **⏻** (Off / On) Power switch on the WALKABOUT phone interface to turn the unit on.
3. Turn the computer power on.

### In-vehicle System

The following is the general procedure for powering up an in-vehicle system. Refer to the navigator installation manual for specific navigator power-up information.

1. Press the **PWR** button on the tracking phone to turn it on.
2. For a system equipped with a SAFCO Navigator Plus or a Clarion Navigator using the permanent power cable (p/n 2037-851), turn the ignition switch on to apply power to the navigator. The WALKABOUT is powered by the in-vehicle power cable (p/n 2037-807) that connects to the navigator's **AUX** power connector.
3. Press the **⏻** (Off / On) Power switch on the WALKABOUT phone interface to turn the unit on.
4. Turn the computer power on. Wait for Windows to initialize.

### WALKABOUT CPU LED

Normally, the CPU LED of the WALKABOUT's phone interface module flashes green to indicate that initialization is complete, and that the phone interface is communicating with the phone and scanner. If it flashes orange, verify that the phone is powered on, and that the phone interface cable is properly connected to the WALKABOUT and to the phone. If reseating the cable connectors does not correct the flashing orange condition, contact SAFCO Customer Support for assistance.

### Removing and Replacing Phones

**Important!** If you exchange (swap) the tracking phone with one of the same type while the WALKABOUT phone interface is powered on, you must perform the following steps after the phone has initialized:

1. Press the **F5** key to open the System Setup view.
2. Right-click on the tracking phone listed. A pop-up menu appears.
3. Click **Reset**.

The alternative is to perform the following steps:

1. Power the WALKABOUT phone interface off
2. Power the phone off.
3. Replace the phone.
4. Power the phone on.
5. Power the WALKABOUT phone interface on.

## The Next Step

Refer to *Chapter 2 — The WALKABOUT Software Display* for an overview of the views that are displayed.

## Chapter 2 — The WALKABOUT Software Display

### Introduction

This chapter describes the features of the WALKABOUT display. The windows that display signal parameters, messages, and call statistics are referred to as *views*.

### Starting the WALKABOUT Software

At this time all of the system components should be powered on, and Windows should be running.

1. Click **Start | Programs | Safco | Walkabout**.
2. Wait for the SAFCO Technologies logo to leave the screen.

Below is an example of a typical display, after it has been configured. You can choose the views that you want to display from the View pull-down menu, then arrange them as you prefer. The next section contains a description of the display features.

**Figure 6**  
Typical WALKABOUT Display

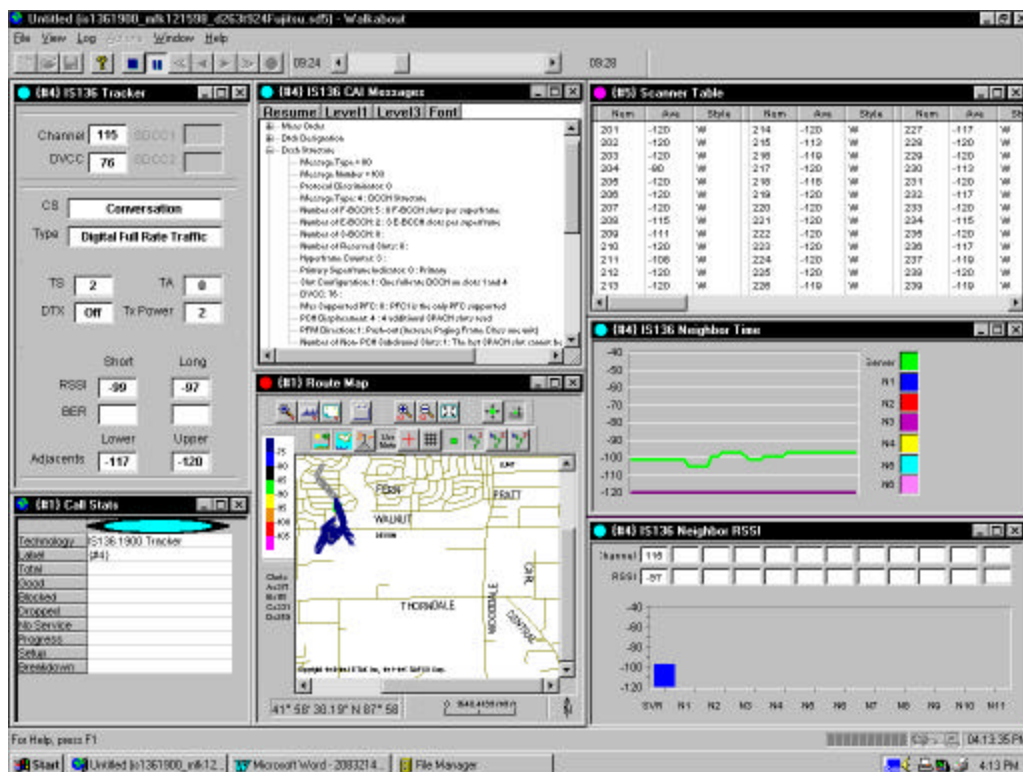





## Display Features







### Main Toolbar

The main toolbar buttons control two types of functions. They are described below and on the next page. You can choose to show or hide the main Toolbar from the View menu. Below are brief descriptions of the commands. More information is contained in the following chapters.

#### *File Control and "About" Buttons*

Button	Name	Action When Clicked
	New	Opens a new instance of the System Setup view. With the view open, right-click on the computer COM port that the system or device is connected to, then click the <b>Refresh Port</b> command on the pop-up menu. This will cause the system devices to be identified.  Use this command when you want to reconfigure the software to work with a new physical configuration of the devices. For more information see <i>Chapter 3 — Device Selection</i> .
	Open	Opens either an .SD5 data file for playback, or an .SPF file (SAFCO Plan File) with different views and options. The Open dialog box is displayed. Locate and select the desired file, then click the <b>Open</b> button.
	Save	Saves any changes made to the Properties dialog boxes or the views displayed on the screen in the current .SPF file.
	About	Shows the software version and copyright.

#### *Data Collection and Replay Buttons*

Button	Name	Action When Clicked
	Stop	Stops logging or replay of a data file.
	Pause	Pauses data collection or replay of a data file.
	Fast Reverse Replay	When replaying a data file in reverse, each click increases the speed, from x 2 through x 7. Click the <b>Reverse Replay</b> button to return to normal speed.
	Reverse Replay	Plays a data file in reverse. The file must be played in the forward direction before this command can be used.
	Replay	Replays a data file. To replay a data file from a previous data collection test, first click the <b>Open</b> button, then select the .SD5 data file.
	Fast Replay	When replaying a data file, each click increases the speed, from x 2 through x 7. Click the <b>Replay</b> button to return to normal speed.
	Start Logging	Initiates a data collection test. The Create Log File dialog box appears. Enter a file name, then click the Save button to begin logging data.

## Menus

The pull-down menus contain typical Windows commands. Buttons on the toolbar described on the previous page are provided for frequently-used menu commands. Below are brief descriptions of the commands. More information is contained in the following chapters.

**Figure 7**  
**Menu Bar**



### **File Menu**

The File menu has the following commands:

- **New:** This command has the same function as the New button in the main toolbar.
- **Open:** This command has the same function as the Open button in the main toolbar.
- **Save:** This command has the same function as the Save button in the main toolbar.
- **Save As:** This command allows you to save the current views and device properties under a different file name.
- **Close:** This command closes the .spf or .sd5 file that is currently open.
- **Export:** This command is used for exporting a data file in a format other than the SAFCO .sd5 format. (See page 99 for more information.)
- **1, 2, 3, etc:** The file list allows you to quickly open a recently used .spf file.
- **Exit:** This command closes the data collection software.

### **View Menu**

The View menu lists the names of all of the available data views for the devices. Click on a name to open the view.

### **Log Menu**

The Log menu has the following commands: Replay, Reverse Replay, Fast Replay, Fast Reverse Replay, Start Logging, Pause, and Stop. They have the same functions as the buttons on the main toolbar.

### **Actions Menu**

The Actions menu has the following commands that are only available while a test is in progress:

- **User Notes:** This command opens a dialog box that allows you to enter comments. The text can be seen in the Route map view if the User Notes layer is on, and also in OPAS32. The keyboard shortcut for this command is **F2**.
- **Survey Markers:** This command opens a dialog box that allows you to add a marker. The markers can be seen in the Route map view if the Survey Markers layer is on, and also in OPAS32. The keyboard shortcut for this command is the Spacebar.

### **Window Menu**

The Window menu has the following commands:

- **Cascade:** Stack all of the open views with the title bars showing.
- **Tile Horizontally:** Resize all of the open views to a predetermined size. With up to three views open, the width exceeds the height.
- **Tile Vertically:** Resize all of the open views to a predetermined size. With up to three views open, the height exceeds the width.
- **Arrange Icons:** Arrange the minimized view icons at the bottom of the main window.
- **View list:** This is the list of open views. Click a name to restore a minimized view.

### **Help Menu**

The Help menu has the following commands:

- **Help Topics:** This command opens the online Help system. (See the description on page 18.)
- **Technical Support:** This command displays the list of SAFCO Technologies locations.

**About Walkabout:** This command opens the dialog box with the software version number and copyright information.

### **Time Bar**

The Time Bar is normally located underneath the main toolbar. You can move it to a new location by dragging its right edge. You can also choose to show or hide the Time Bar by clicking its name on the View menu.

During playback of a data file, the start and end times are indicated. If playback speed is x 2 or greater, the rate is indicated. Also during playback, you can drag the slider to any point on the bar to view another part of the data file, then release the mouse button continue playback. If you drag the slider to the left to review a data collection test in progress, a  icon appears on the Time Bar. Click this icon to return to the real-time display of data.

**Figure 8**  
**Time Bar**



## Status Bar

The Status Bar is located at the bottom of the screen. Show or hide it by clicking Status Bar on the View menu. The left side of the status bar is used to display text messages. The right side of the status bar contains the following items:

- A battery charge level icon (for the WALKABOUT battery only)
- A bar graph showing the amount of disk space available
- A communication status icon (the section showing a globe, a phone, and a PC)
- A clock

**Figure 9**  
**Status Bar - Right Section**



### ***Battery Charge Level Icon***

The battery icon changes color to indicate the level of its charge. Green indicates a full charge, yellow indicates a 2/3 charge, and red indicates that the battery has discharged to a critical level. You can also configure an audio alert to sound if the WALKABOUT battery discharges to a critical level during a test. Refer to page 73 for the procedure.

### ***Connection Status Icon***

If communication with any device is lost during a test, after the time specified on the Cable Connection tab of the Options Dialog box, a flashing red  $\emptyset$  symbol will appear in the connection status icon.

## Using Online Help

The online help contains detailed information about the WALKABOUT software. It can be accessed in three ways:

- While the WALKABOUT software is running: Click the **Help** button in the Properties dialog, or press the **F1** key. (Context-sensitive help appears.)
- While the WALKABOUT software is running: On the main menu bar, click **Help | Help Topics**. The Help Topics dialog box appears.
- From the Windows Start menu: Click **Start | Programs | Safco | Online Help**. The Help Topics dialog box appears.

**Figure 10**  
**Help Topics View**

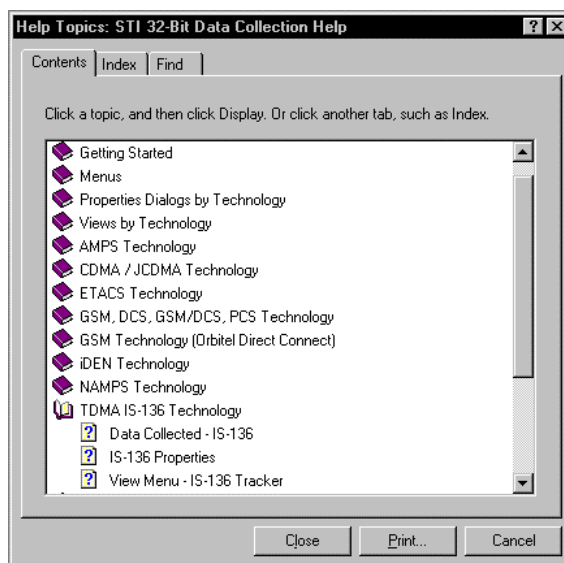

The Help Topics view contains the following tabbed pages:

- The **Contents** tab allows frequently used topics to be accessed quickly.
- The **Index** tab lets you search a list of all topics and keywords.
- The **Find** tab lets you search for words throughout the help file.

While a help topic is displayed, click the **Help Topics** button to redisplay the Help Topics view.

### For information about a Properties dialog box

- Double-click the book for the technology of the device. The available topic pages are displayed.
- Highlight the Properties page, then click the **Display** button. The information about configuration is displayed.

### For information about views

- Double click the book for the technology of the device. The available topic pages are displayed.



- Highlight the Views page, then click the **Display** button. The information about the views for the technology is displayed.

**For information about performing a survey**

- Double-click the Performing a Survey book.
- Highlight the appropriate page, then click the **Display** button. The information about data collection is displayed.

## The Next Step

Refer to *Chapter 3 — Device Selection* for information on how to configure the software to recognize the devices.



## Chapter 3 — Device Selection

### Introduction

After you install the system and start the data collection software, the next step is to select the devices. Using an automated process, the software identifies the tracking phone, scanner, and navigator, if equipped.

The following procedure is typically only performed after you connect the system cables for the first time. However, you must also perform this procedure if you have replaced a device with one of a different technology or model than the original, or if you have reinstalled the system using a different computer serial port than the one that was originally used.

### Identify the Tracking Phone and Scanner

The following instructions apply to a WALKABOUT system connected to the computer, or to a WALKABOUT connected to a SAFCO Navigator Plus that is connected to the computer.

1. Verify that all equipment is connected and powered on.
2. Start the data collection software by double-clicking the WALKABOUT shortcut, or by clicking **Start | Programs | Safco | Walkabout**.
3. Click **File | New**. The System Setup view appears.

**Figure 11**  
**System Setup View (New System)**



Right-click on the COM port that the Walkabout or Navigator Plus is connected to.

4. Right-click on the computer COM port that the WALKABOUT or Navigator Plus is connected to. A pop-up menu appears.
5. Click the **Refresh Port** command. After approximately 30 seconds, the tracker, scanner, and Navigator Plus (if equipped) will be identified, and a dialog box will appear.
6. Click the **Detail** button to show the devices that were detected.
7. Click the **Yes** button to accept the configuration.

## Identify the Navigator

The following instructions apply to Trimble Placer, Clarion, and Garmin GPS navigators that are connected to a separate COM port of the computer.

1. Verify that the navigator and the computer are both powered on.
2. Open the System Setup view as described previously.
3. Right-click on the computer COM port in the System Setup view that the navigator is connected to. A pop-up menu appears.
4. Click the **Refresh Port** command. After approximately 30 seconds, the navigator will be identified, and a dialog box will appear.
5. Click the **Detail** button to show the device that was detected.
6. Click the **Yes** button to accept the configuration.

## Enable the Devices

You must enable the devices in order to collect data from them. If it is not already displayed, press the **F5** key or click **View | System Setup** to display the System Setup view. Note that the example below shows a Navigator Plus with a WALKABOUT connected to it. For a WALKABOUT without a navigator, only the WALKABOUT system would appear under COM1. For a system with a Garmin or Trimble navigator, the navigator would appear under one COM port, and the WALKABOUT system would appear under another COM port.

1. If it is not already displayed, press the **F5** key or click **View | System Setup** to display the System Setup view.
2. Verify that the check boxes are checked for the tracker and the scanner.
3. If your system is equipped with a navigator, click the check box for one of the following:
  - If you plan to do an in-building survey, click the check box next to In Building Navigator.
  - If your system is equipped with a SAFCO Navigator Plus, click the check box next to Navigator.
  - If your system is equipped with a Trimble Placer, click the check box next to TAIP Navigator.
  - If you have installed an ETAK Skymap GPS PCMCIA card or a Garmin GPS II Plus navigator, click the check box next to NMEA Navigator.

**Figure 12**  
**System Setup View (Typical Configured System)**

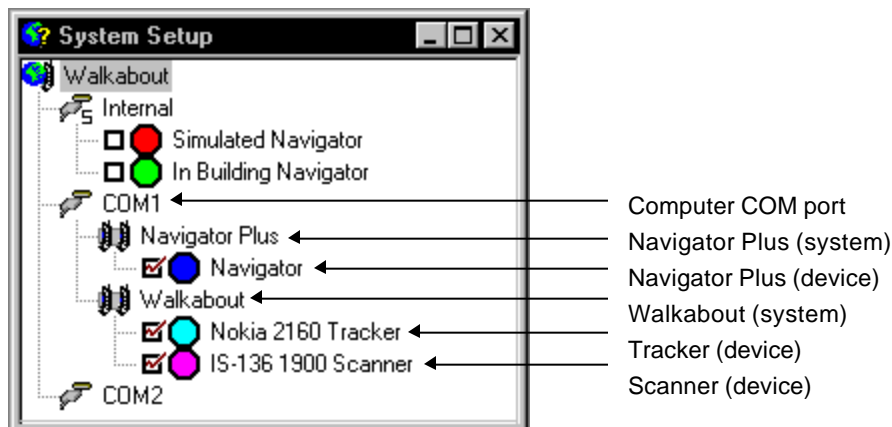

## Save the Configuration

1. Click **File | Save As**.
2. Enter a file name in the Save As dialog box.
3. Click the **Save** button. The configuration is saved as an .spf file (SAFCO Plan File). The display will automatically initialize with this configuration the next time you start the software.

---

**Important!** Do not close the System Setup view unless at least one other view is open. On the menu bar click **View**, then choose any other view from the pull-down menu. To free up screen space, minimize or close the System Setup view after saving the configuration.

If you close the System Setup view with no other views open, no configuration file will be selected. Refer to the procedure on page 84 and open the .spf file.

---

## Reviewing the Configuration

You can display the System Setup view to review the configuration at any time. This is useful if you disconnect the computer from the system after a survey, then, at a later time, want to reconnect the cables to the same serial ports. To display the System Setup view, press the **F5** key, or click **View | System Setup**.

## System Setup View Pop-up Menus

The pop-up menus allow you to perform functions associated with COM ports, systems (WALKABOUT and navigator), the tracking phone, and the scanner.

### Com Port Pop-up Menu

Right-click on the COM port (COM1, COM2, etc.) that the WALKABOUT system is connected to. The pop-up menu contains the following three commands:

- **Refresh Port:** This command was described previously.
- **Reset Port:** This command is used after you physically remove a system or a direct-connect phone from a serial port. After resetting the port, the software will not associate any system or device with it.
- **Delete Port:** This command is currently not available.

### WALKABOUT System Pop-up Menu

Right-click on the **Walkabout** text as shown in the System Setup view. (See the previous page.) A pop-up menu appears with the following commands.

- **System Software:** This command is currently not available.
- **Reset:** This command performs a “system reset” to initialize the system.
- **About:** This command displays a dialog box showing the firmware version of the WALKABOUT. Click **OK** to close it.

## Tracker Pop-up Menu

Right-click on the Tracker (tracking phone) shown in the System Setup view. The pop-up menu that appears contains the following commands.

- **Application Software:** With the mouse pointer pointing at this item, the Replace command appears.

---

**Important!** Clicking **Replace** opens the Replace dialog box, that allows you to replace a system file. This may (or may not) be necessary after you have installed a new release of the data collection software. You must contact Customer Support for assistance before using this command.

---

- **Edit Label:** This command opens the Modify Device Label dialog box, that allows you to add a text label to the device. The label is displayed in the title bar of the views for the device, and appears in the data file.

**Figure 13**  
**Modify Device Label Dialog box**

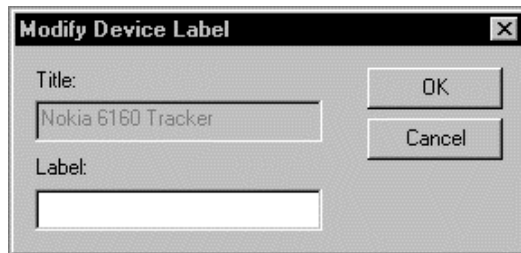

- **Properties:** This command opens the Properties dialog for the tracker. (This is described in *Chapter 5 — Device Configuration*.)
- **Reset:** This command resets the tracking phone.
- **About:** This command displays a dialog box containing information about the tracking phone, such as the description and software version. Click the **Close** button to close it..

## Scanner Pop-up Menu

Right-click on the Scanner shown in the System Setup view. The pop-up menu that appears contains the following commands.

- **Application Software:** This command has no function at this time.
- **Edit Label:** This command has the same function as was described for the tracker on the previous page.
- **Reset:** This command resets the scanner.
- **About:** This command displays information about the scanner, as shown below. Click the **Close** button to close it.

**Figure 14**  
**About Dialog Box for a Scanner (Typical)**

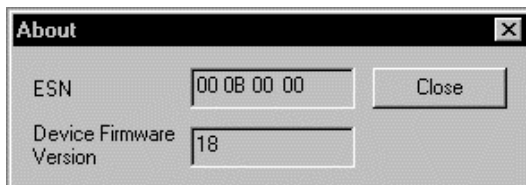

## Navigator Pop-up Menu

Right-click on the Navigator shown in the System Setup view. Depending on the navigator, the pop-up menu that appears contains commands described in the previous sections.

## The Next Step

Refer to *Chapter 4 — Views* for information on how to select and configure the views for the display.



## Chapter 4 — Views

### Introduction

After the devices have been selected, the next step is to configure the computer display. The windows that display the real-time parameter measurements and graphs are referred to as *views*.

On the main menu bar, click **View**. The pull-down menu lists the views available for the devices that have been identified. Select each of the views that you want to display. Resize and arrange the views as needed.

This chapter contains procedures for configuring the following views: Route Map, Scanner, Call Stats, Carrier vs Interferer, Monitor Settings view, and Time Chart. Connection status alerts are also described in this chapter. A connection status alert can be set to play a .wav file when communication between a device and the software is lost.

### DFI Selector View

The DFI Selector view is a tree of folders which, when fully expanded show all of the parameters that are collected. The raw data from the *Device* is packaged into *Frames*. Frames contain related *Items* (parameters that are collected). With the DFI Selector view displayed, click the plus boxes  $\oplus$  to show the branches (subordinate levels) of the tree.

This view is displayed when you are prompted to select a channel or signal parameter for a user-configurable view. (The DFI Selector is not listed on the View menu.) User-configurable views that use the DFI Selector view include the Route Map view, the Monitor Settings view, and the Time Chart view.

In the figure below, TDMA(1) – Nokia 2160 Tracker (#4) is a *Device*, Signal is a *Frame*, and Channel is an *Item*.

**Figure 15**  
**DFI Selector View**

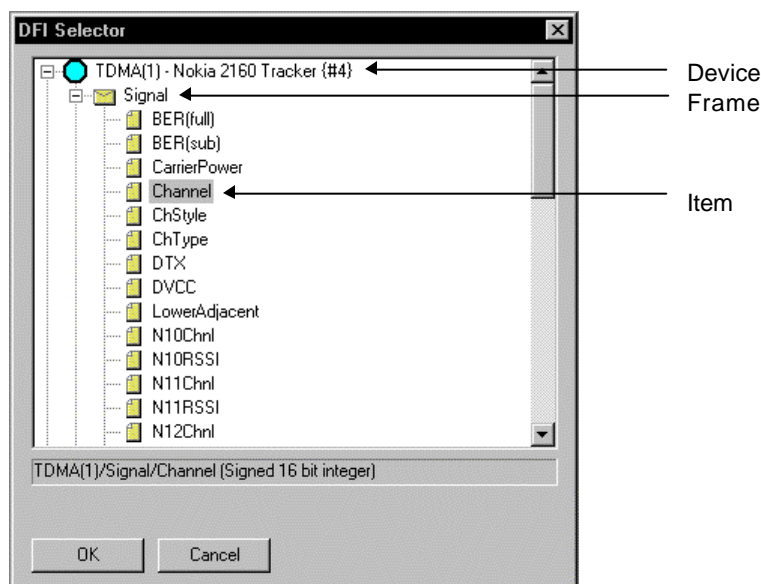

## IS136 CAI Messages View

This view displays the Common Air Interface messages as they occur. These include Analog Channel Overhead messages, Analog Channel Order messages, Traffic Channel messages, User Interface messages, and DCCH messages. Messages can be decoded while a test is running or being played back.

Click the check boxes for the types of messages that you want to log on the Enable Mask tab of the IS136 Properties dialog box. The Primitives check box must also be checked on the Param Mask tab of the dialog.

**Figure 16**  
**IS136 CAI Messages View**

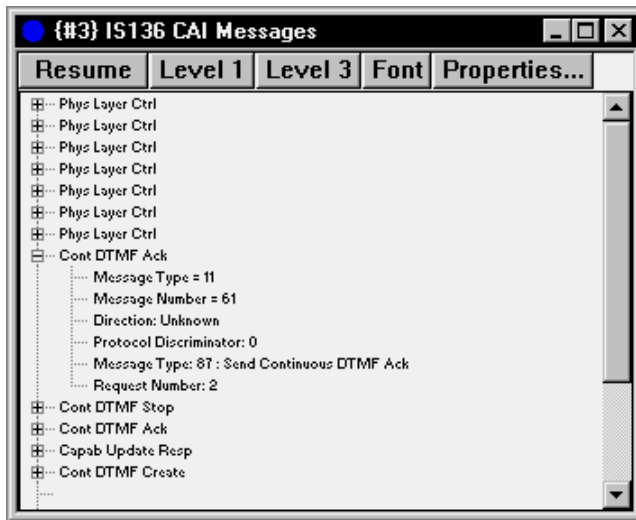

The following buttons appear at the top of the view.

- **Pause / Resume:** Click this button to halt the display of new messages. (The button title changes to Resume.) Individual messages can be decoded by clicking the plus box next to the message.
- **Level 3:** Click this button to decode all of the messages that are displayed while the view is paused.
- **Level 1:** Click this button to return to the undecoded message view while the view is paused. (This is the default when the view is first paused.)
- **Resume:** When the view is paused, click this button to start displaying new messages again.
- **Font:** Click this button to change the character font within the view.
- **Properties:** Click the button to display the Properties dialog box for this view.

## Properties Dialog Box – IS136 CAI Messages View

The Properties dialog box allows you to control which messages are displayed in the IS136 CAI Messages view. To open it, click the **Properties** button in the IS136 CAI Messages view.

This dialog box also enables pop-up views or “message boxes”, that display all of the messages of one type. For more information, see the *Notify Section* heading below.

---

**Note:** The selections in this dialog box do not affect the settings on the Enable Mask tab of the IS136 Properties dialog box. However, messages must be enabled on the Enable Mask tab and in the Properties dialog box in order to display them in the IS136 CAI Messages view.

---

**Figure 17**  
**Properties Dialog Box: IS136 CAI Messages View**

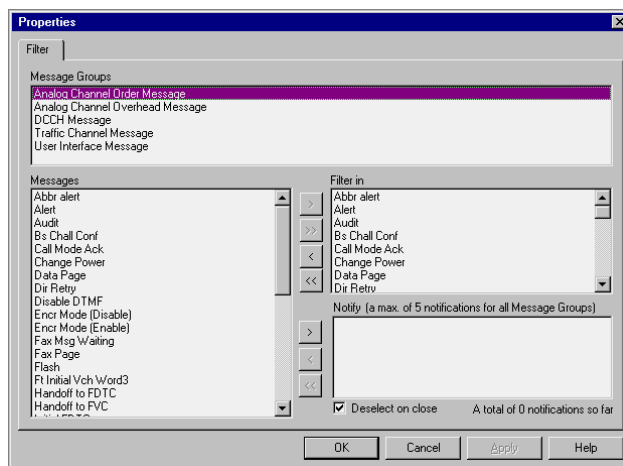

### Message Groups Section

The section contains the following channels: Analog Channel Order Message, Analog Channel Overhead Message, DCCH Message, Traffic Channel Message, and User Interface Message.

### Messages Section

This section contains the messages pertaining to the channel highlighted in the Message Groups section above. Messages selected in this section can be added to the Filter In section and the Notify section as described below. Message types are moved to and from this section.

### Filter In Section

This section lists the messages that will be displayed in the IS136 CAI Messages view. All message types are included in this section by default.

- To remove a message (i.e. filter it out): Select the message in the Filter In section, then click the < (left-arrow) button in the upper group. To remove all of the messages from the Filter In section, click the << (double left-arrow) button.
- To add a message (i.e. filter it in): Select (highlight) the message in the Messages section, or hold down the **Ctrl** key while you select multiple messages, then click the > (right-arrow) button in the upper group. To add all of the messages to the Filter In section, click the >> (double right-arrow) button.

### **Notify Section**

You can display up to five message types in separate pop-up views (message boxes) as they occur, during data collection or playback. The total number of message boxes enabled is indicated in this section.

- To enable a message box: Select (highlight) a channel in the Message Groups section, then select the message in the Messages section, or hold down the **Ctrl** key while you select multiple messages, then click the > (right-arrow) button in the lower group.
- To disable a message box: Select the message in the Notify section, then click the < (left-arrow) button in the lower group. To remove all of the messages from the Notify section, click the << (double left-arrow) button.
- To close a pop-up message box, click the  button in its title bar.

**Figure 18**  
**Traffic Channel Message Box**

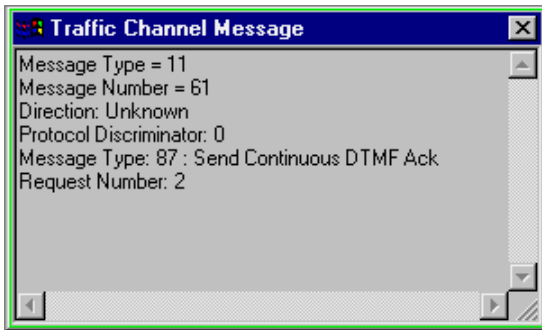

### ***Deselect on Close Check Box***

If this box is checked (the default), the message type will be removed from the Notify section when you close its message box. A new message box will not appear when the next message of that type is received. Uncheck the Deselect on Close check box to disable this feature.

### ***Closing the Properties Dialog Box***

Click the **OK** button to close the dialog box and save the changes.

## IS136 Neighbor RSSI View

This view shows the signal strength of up to 11 neighbor digital control channels. In order to display neighbor data, you must enable (check) the Neighbors check box on the Param Mask tab of the IS136 Properties dialog box.

**Figure 19**  
**IS136 Neighbor RSSI View**

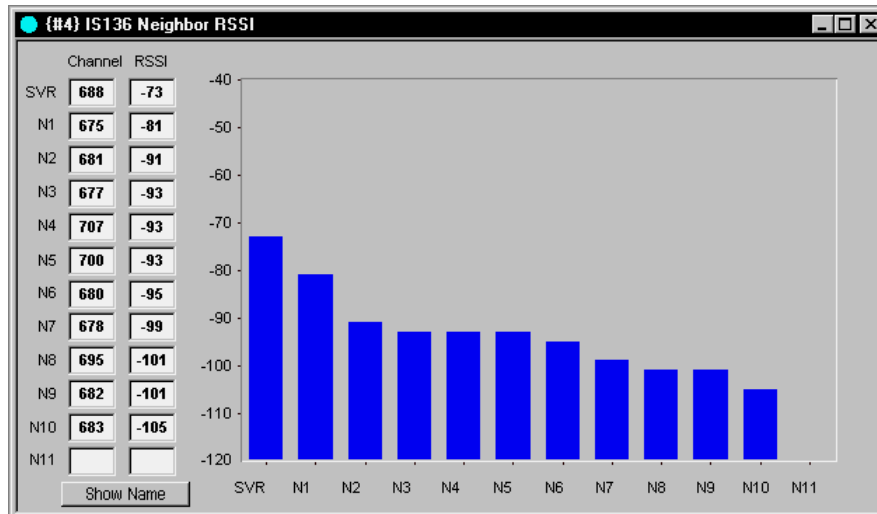

### Cell Site Name

You can also display the cell site name for the serving channel and up to 11 neighbors, if a cell site database has been selected.

1. Click the **Show Name** button. The button caption changes to “Show Channel”
2. Right-click on the Show Channel button. A pop-up menu appears. Choose “Use Channel” or “Use Channel and Qualifier” to determine how the cell site name is resolved for the serving cell and neighbors.

The cell site name is displayed next to the RSSI measurement.

## IS136 Neighbor Time View

This view is a graph of the signal strength of up to six neighbor digital control channels. To display neighbor RSSI, you must click (to check) the Neighbors check box on the Param Mask tab of the IS136 Properties dialog box.

**Figure 20**  
IS136 Neighbor Time View

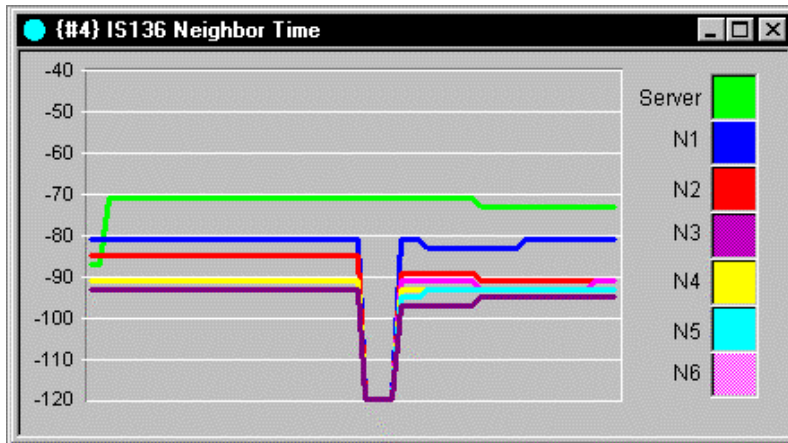

## IS136 Tracker View

This view displays the call tracking parameter values. To display all of the parameter values, the Tx Power Level, IS-136 Digital Quality, Time Advance, and IS-136 Channel check boxes must be checked on the Param Mask tab of the IS-136 Properties dialog box.

**Figure 21**

**IS136 Tracker View** Right-click on “Channel” to display the cell site name.

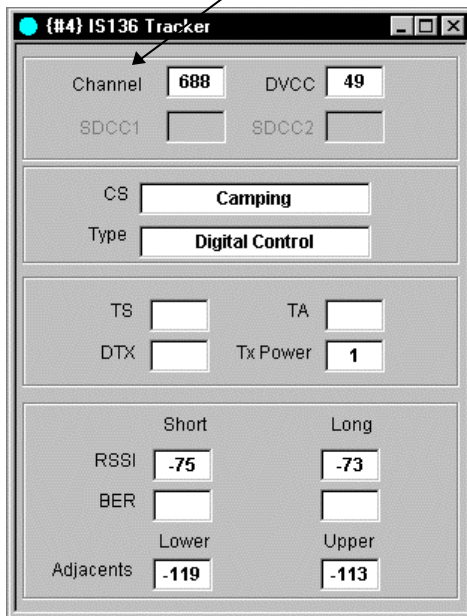

The following fields appear in the view:

- **Channel:** This field displays the server channel number.
- **Cell Site Name:** You can display the cell site name if you have selected a cell site database. (Refer to page 74 for the cell site database selection procedure.)

To display the cell site name, follow these steps:

1. Right-click on the **Channel** label. (See the arrow in the figure above.) A pop-up menu appears.
2. Click **Show Name** on the pop-up menu. The Channel label changes to “Cell Name”.
3. Right-click within the Cell Name data field. A pop-up menu appears.
4. Choose Use Channel or Use Channel and Qualifier as the ID source.
5. To hide the cell site name, right-click on the Cell Name label, then click **Show Channel** on the pop-up menu.

- **Server Color Code:** This field displays the DCC , SAT or DVCC.
- **SDCC1:** This field displays the Supplementary Digital Color Code 1.
- **SDCC2:** This field displays the Supplementary Digital Color Code 2.
- **CS (Call State):** This field displays the current call-processing status of the phone.

- **Type:** This field displays one of the following messages: Analog Control, Analog Voice, Digital Control, Digital Traffic.
- **TS (Time Slot):** This field displays the time division slot for current communications.
- **TA (Time Alignment):** This field displays the absolute timing offset from the standard offset reference position.
- **DTX:** This field displays the Discontinuous Transmission indicator (On or Off).
- **TX Power:** This field displays the following based on channel type:
  - Analog Control: CMAC (valid values are 0 - 7)
  - Analog Voice: VMAC (valid values are 0 - 7)
  - Digital Control: DMAC (valid values are 0 - 10)
  - Digital Traffic: Tx Power (valid values are 0 - 10)
- **RSSI (short):** This field displays the received signal strength indicator (RSSI). The value reported is the average of 5 signal strength measurements.
- **RSSI (long):** This field displays the received signal strength indicator (RSSI). The value reported is the average of 25 signal strength measurements.
- **BER (short):** This field displays the Bit Error Rate. The value reported is the average of 5 BER measurements.
- **BER (long):** This field displays the Bit Error Rate. The value reported is the average of 25 BER measurements.
- **Adjacents:** This field displays the signal strength (in dBm) for the lower and upper adjacent channels. These measurements are obtained from the scanner. Therefore, if a dual-band tracking phone is in the PCS band and the scanner is in the Cellular band, the adjacent channel measurements will be from channel numbers in the Cellular band.



## Route Map View

### Introduction

This section describes the features of the Route Map view. The functions of the Route Map buttons are described first, followed by detailed configuration instructions.

The Route Map view allows you to display an image of the area you plan to survey. (You must provide the .bmp, .map, or .mif file.) You can also display a bitmap image of the floor plan of a building that you plan to survey. To configure this view, start by selecting the map in the *Configuring the Route Map* on page 40, then proceed with the sections about configuring the layers that follow.

If you are using Paced mode, you will not need to select a map file. To configure the Route Map view for Paced mode, follow the procedure in the *Entering the Map Location* section under *Configuring the Route Map* on page 40, then proceed with the sections about configuring the layers that follow. The data collected during the survey will then be referenced to the starting latitude / longitude position.

The Route Map view contains the following layers, which can be shown or hidden as needed: Map Picture or Street Map, Cell Site, User Notes, Survey Markers, Grid, Current Position, and three Signal layers. To display a layer, click the button so that it has a recessed look.

All of the layers except the User Notes layer have user-configurable options that are accessed via Properties dialog boxes. Procedures for configuring the layer properties begin on page 43. Additional information can be found in the online help for the WALKABOUT software.

If you have a portable system without a navigator and are performing an in-building survey, click **View | In Building Route Map**. If your system is equipped with a navigator and you are performing an in-vehicle survey, click **View | Route Map**. The Route Map view appears.

**Figure 22**  
**Route Map View**

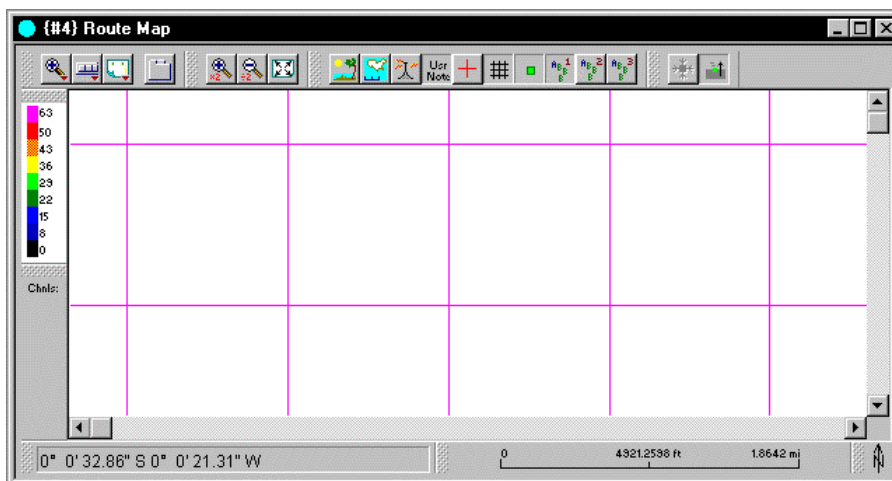

**Tip:** Create a Maps folder on the hard drive, then copy the map files (.bmp, .map, or .mif) that you plan to use from the map CD to the new folder.

## Route Map Buttons

The Route Map view buttons (also referred to as *tools*) are grouped together in four sections:





- Button Bar
- Zoom buttons
- Current Position buttons
- Layer buttons

The button functions are described below and on the following pages. Other Route Map features, including the Color Scheme, Channel List, Status Bar, Map Scale, and Compass are described on page 39.

### Button Bar

The Tool Menu, Bar Menu, Layer Menu, and Properties buttons are grouped together in the upper left corner of the view.

 **Tool Menu:** This button controls the function of the mouse pointer. Choose one of the following functions on the pull-down menu. The button icon changes to indicate the selected function, as shown below.

Button	Name	Action When Clicked
	Zoom In	Click and drag a rectangle around the area of the map that you want to zoom in on.
	Zoom Out	Click and drag a rectangle around the area of the map that you want to zoom out on.
	Distance	Click and drag a circle anywhere on the map to measure distance. The distance from the center point to the outer circle is indicated in the Status Bar text area.
	Signal	During a data collection test, click on a data point. The measurement at that point is displayed in the Status Bar text area. (The Route Map Signal layers must be configured and enabled for this feature to function.)

 **Bar Menu:** Click this button to display a pull-down menu. You can show or hide the following Route Map features and button groups: Channel List, Zoom Buttons, Current Position Buttons, Layer Buttons, In-Building Navigation, Map Scale, Compass, Status Bar, Button Bar, and Color Scheme.

**Tip:** If you accidentally hide the Button Bar, right-click within the Route Map view, then click **Bars | Button Bar** to show it again.

 **Layer Menu:** Click this button to display a pull-down menu. You can show or hide the following layers on the map: Cell-Site, Map Picture, User Notes, Survey Markers, Grid Layer, Current Position, and Signal.

If the button bars are displayed (see *Bar Menu*, above), then the Route Map buttons can be used instead of this menu.



**Properties:** Click this button to display the Route Map 2 Host Properties dialog box. This dialog box allows you to change the following properties:

- **Measurement System:** This selection determines the units of measure. Choose Metric, U.S. or Use Regional Settings (from Control Panel). Regional Settings uses the region chosen in the Windows 95 or NT Regional Settings Properties dialog box.
- **Distance represented by one pixel:** Accept the default, or enter a higher value to show less detail on the map; enter a lower value to show more detail.
- **Background:** Click the button, then select a color for the map background.
- **Border Width:** Click the arrow buttons to change the width of the route map border.
- **Border Relief:** Choose Flat, Raised, or Sunken to apply an effect to the border.

### **Zoom Buttons**

The Zoom buttons are grouped together next to the Button Bar. Use these buttons to resize the map.

Button	Name	Action When Clicked
	Zoom In x 2	Zoom in on the center of the map to show twice as much detail.
	Zoom Out / 2	Zoom out on the center of the map to show twice as much of the map with half of the detail.
	Show All Points	Show all data points on the map.





### **Current Position Buttons**

The Current Position buttons are grouped together next to Zoom buttons. Use these buttons to make the current position visible.

Button	Name	Action When Clicked
	Show Current Position	Center the map around the current position.
	Auto Scroll	Automatically scroll the map so that your current position is always visible.

### ***In-building Survey Buttons***

The following buttons appear when you start an in-building data collection test.

Button	Name	Action When Clicked
	Update Position	While performing an in-building survey, walk to a point where you plan to change direction, click the point on the map, then click this button to update the Route Map.
	Next Position	Click this button to display the In Building dialog box, then enter your next latitude / longitude position.
	Walking / Not Walking	Click (to depress) the button when you start walking. Click the button a second time when you stop walking.
	Paced Mode	When you start a Paced Mode survey, click this button to display the In Building dialog box. (Use Paced mode if you are walking the survey route without having a map displayed in the Route Map view.)







### ***Layer Buttons***

The Layer buttons are grouped together on the right side of the view. Use these buttons to show or hide the layers that you want to display.

---

**Note:** The Map Picture and Street Map layers cannot be selected at the same time.

---

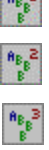
Button	Name	Action When Enabled
	Map Picture Layer	Show the selected map.
	Street Map Layer	Show the selected Street Map when the test or playback begins.
	Cell-Site Layer	Show the names of the cells. A line from the active cell to the current position is drawn. You must select a cell-site database if you are showing this layer. (This is described on page 46.)
	User Notes	Show the notes you have entered.
	Survey Markers	Show the survey markers you have entered.
	Grid	Show the reference grid.
	Current Position	Show the current position indicator.
	Signal	Show the color-coded signal value and the letter associated with the channel at the data point. There are three signal buttons available. You can specify a different channel / signal combination for each button. (Refer to page 43 for more information.)

## Text Areas and Indicators

The following features are shown in the Route Map View example on page 35. You can choose to show or hide any of these features on the Bar Menu. The default is to show all of them.

- **Color Scheme:** A legend that indicates the range of measurement for each color is shown on the left side of the view.
- **Channel List:** A list of the active channels and their corresponding letters is shown on the left side of the view, under the Color Scheme.
- **Status Bar:** A text area used to display messages and data associated with the mouse pointer is shown at the bottom left corner of the view. For example, when the Distance or Signal function is selected (using the Tool Menu button), the measurement is displayed in this area.
- **Map Scale:** A distance reference scale is shown at the bottom center of the view. The scale is affected by the Zoom buttons and the Width Represented by Picture value entered on the Map Picture Properties dialog box.
- **Compass:** A pointer that indicates the relationship of the map to true north relative to the screen is shown at the bottom right corner of the view.

## Configuring the Route Map

The following sections describe the Properties dialog boxes that are used to configure the Route Map view. You can use either a bitmap (.bmp) map graphic file as described below or a street map (.map or .mif) file, but you cannot use both at the same time. Also see *Street Maps Layer Properties* on the next page.

### Map Picture Layer Properties

This dialog box allows you to select the map file, its latitude / longitude, and its size.

#### Selecting a Map Graphic File

1. Right-click on the **Map Picture Layer** button.  The Map Picture Layer Properties dialog box opens.

**Figure 23**  
Map Picture Layer Properties Dialog Box

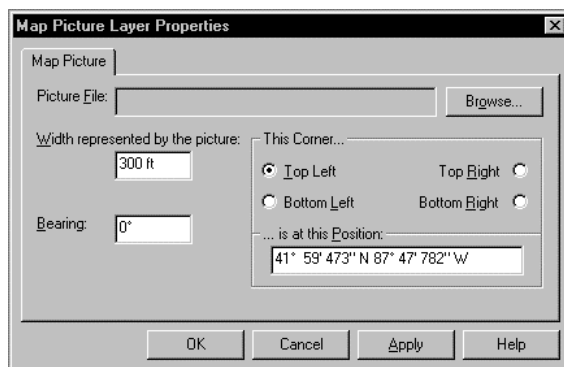

2. Click the **Browse** button. The Open dialog box appears.
3. Locate and select the .bmp (bitmap graphic) file of the map that you plan to use.
4. Click the **Open** button. The Open dialog box closes, and the file name is entered in the Picture File field of the Map Picture Layer Properties dialog box.



#### Entering the Map Location

1. Enter a value (in meters) for the Width Represented by the Picture.
2. Enter a bearing, if appropriate. This is an offset from north, with north being 0 degrees. Degrees increase in a counter-clockwise manner.
3. In the This Corner... section, choose a corner of the map.
4. Enter the latitude and longitude for the corner that you have chosen.

The format is: ddd° mm' ss.s" N ddd° mm' ss.s" W

where d = degrees, m = minutes, and s = seconds. Enter the appropriate direction letter (N, S, W, E) for your location.

5. Click the **OK** button to close the dialog box.

6. Click the **Zoom In x 2**  or **Zoom Out / 2**  buttons to adjust the map scale so that the map is visible. The scale at the bottom of the view changes accordingly. Next, use the scroll bars to center the image.

## Street Maps Layer Properties

Right-click on the Street Maps Layer button.  The Street Maps Layer Properties dialog box allows you to select the street map (.map file) and other features of the map, or to select a MapInfo map (.mif file).

---

**Important!** The Street Map Layer Properties must be configured before you begin a data collection test. If you plan to use street maps (.map or .mif files) in the Route Map view, and your computer is running Windows 95 or 98, you must first copy the maps from the map CD to the computer's hard drive. Selecting multiple map files directly from the CD-ROM may result in an "out of memory" error for Windows 95 and 98 users. We recommend that Windows NT users also copy the map files to the hard drive.

---

**Figure 24**  
**Street Maps Layer Properties Dialog Box**

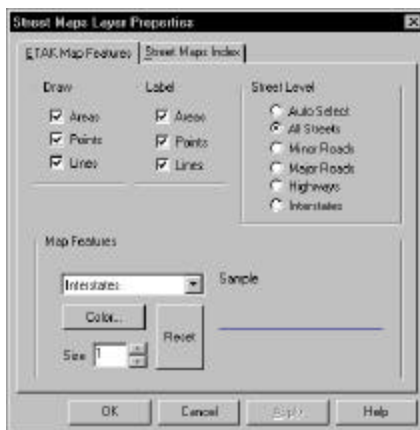

### **Street Map Features Tab**

The following options are selected on this tab.

#### **Draw**

This section allows you to choose the items of the street map that are drawn in the Route Map view.

- Click the Areas check box to draw areas, such as parks and water bodies.
- Click the Points check box to draw points of interest, such as airports.
- Click the Lines check box to draw streets, roads, highways and interstates. (See Street Level, below.)

#### **Label**

This section allows you to choose the items of the street map that are labeled.

- Click the Areas check box to label areas.
- Click the Points check box to label points of interest.

- Click the Lines check box to label streets, roads, highways and interstates.

### Street Level

This section allows you to choose the level of line detail. The level of detail you select includes the levels listed below it. The choices are:

- **Auto Select:** Display street information for optimum viewing within the window.
- **Streets:** Display all streets, minor roads, major roads, highways, and interstates.
- **Minor Roads:** Display minor roads, major roads, highways, and interstates.
- **Major Roads:** Display major roads, highways, and interstates.
- **Highways:** Display the highways and interstates.
- **Interstates:** Display the interstates only.

### Map Features

Use the following procedure to select a different color and / or line size for each map feature.

1. Choose a map feature in the list box.
2. To change the color, click the **Color** button, then select a color from the Color palette. Click the **OK** button to close the Color palette.
3. Click the up and down arrow buttons (next to Size) to change the line size, in pixels.
4. Click the **OK** button to close the dialog, or click the Street Maps Index tab to select the street map(s) that you plan to use.

To return the color scheme and line widths to the defaults, click the **Reset** button.

### Street Maps Index Tab

This tab allows you to select the street maps or MapInfo maps that will be displayed in the Route Map view during the survey. If multiple .map or .mif files are listed in the index, they are drawn in the order that they are listed.

An .smi file will have to be created before the MapInfo file (.mif) can be used for a survey. When you select the .mif for the first time, a dialog box will appear with the following message: “Creating a SAFCO MapInfo Index File can take a long time. Do you wish to continue?” Click **Yes** to automatically create the file. After the .smi file has been created, you can use the .mif file for a future survey without having to create another .smi file. Because the .smi file creation process can take up to 30 minutes, you are given the option to not create the file. However, if you choose not to, you cannot use the .mif map file for the survey. Use the following procedure to select the maps.

1. Click the **Add** button. The Open dialog box appears.
2. Locate and select the .map or .mif file that you plan to use for the survey.
3. Click the **Open** button to add the .map or .mif file to the Street Map Index.
4. Optional: Repeat steps 1 through 3 to add more maps to the index.
5. Click the up and down arrow buttons to change the order of the maps in the list.



6. Click the **OK** button to close the dialog box, or click the street **Map Features** tab to select map display options. The .mif type maps have no Street Map Features.
7. To remove a map from the list, highlight the .map file, then click the **Remove** button.

---

**Tip:** If you have two maps of the same area in the list and one shows greater detail than the other, click the up and down arrow buttons to position the map with less detail above the map with greater detail.

---

## Signal Layer Properties

This dialog box allows you to select channel and signal parameter measurements to be plotted. Using the following procedure, you can select a signal strength, a channel, or a signal strength and channel combination. Three separate layers are available. Examples of channel and signal strength combinations are given on the next page.

During a test, if the channel parameter is specified, a letter representing the channel is plotted. However, if the channel parameter is omitted, "?" symbols appear.

If a signal strength parameter is specified, the channel letter or "?" is color-coded to indicate the value. Otherwise, it is colored gray. The legend of ranges for colors appears at the left side of the view.



During a test, if data collection is paused, no tracking or scanning data is written to the data file. However, the Route Map is updated with new position information. Position updates while data collection is paused are indicated by dots, instead of the usual letters or question marks.

Right-click on one of the **Signal** layer buttons.  The Signal Properties dialog box appears.

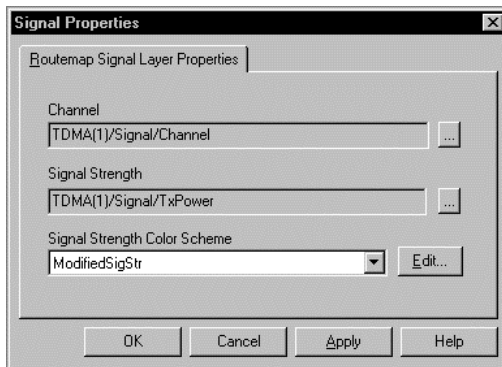

**Figure 25**  
**Signal Properties Dialog Box**



### Specifying a Channel

1. Click the select button for the Channel field.  The DFI Selector view appears. (Refer to page 27 for details about the DFI Selector view.)
2. Click the plus boxes to show the subordinate levels of the tree. 
3. Select a channel that contains a signal strength parameter.
4. Click the **OK** button.

### ***Specifying a Signal***

1. Click the select button for the Signal Strength field.  The DFI Selector view appears. (Refer to page 27 for details about the DFI Selector view.)
2. Click the plus boxes to show the subordinate levels of the tree. 
3. Select a signal strength parameter.
4. Click the **OK** button.

### ***Channel and Signal Strength Examples***

In the following examples, Channel and Signal Strength are listed under the Signal frame in the DFI Selector view.

Channel	Signal Strength
Channel	Tx Power
Channel	BER (full)
Channel	RSSI (full)
Lower Adjacent	RSSI (full)
N1Chnl	N1RSSI

### ***Specifying a Signal Strength Color Scheme***

Color Schemes are shared between the data collection software and OPAS32. To specify a color scheme:

1. Specify a Signal Strength as described previously.
2. Click the Signal Strength Color Scheme down-arrow to display the list box.
3. Select a color scheme.
4. Click **OK** to close the Signal Properties dialog box.

### ***Editing the Color Scheme***

The Edit Color Scheme dialog box allows you to define the range of values and colors for a signal plotted on the Route Map. It is displayed when you click the Edit button in the Signal Layer Properties dialog box.

The following items appear in the dialog box:

- **Scheme:** Click the down arrow to display the color scheme that you want to modify or use as an example for a new scheme.
- **Save As:** Click this button to save the current Scheme using a different name.
- **Delete:** Click this button to delete the current Scheme.
- **Auto Generate Values:** See the procedure below for instructions.
- **Apply:** Click this button to view and save the changes you make.
- **Close:** Click this button to close the dialog box.

### ***Generating New Signal Ranges***

Use the following procedure to add or delete signal ranges.

1. In the Route Map view, right-click on the Signal button that you want to define the ranges and colors for. The Signal Layer Properties dialog box appears.
2. Select a Signal Strength, if it has not already been selected.
3. Click the **Edit** button. The Edit Color Scheme dialog box appears.
4. Select a Scheme from the list box.
5. Click the **Save As** button. The Save As dialog box appears.
6. Enter a different name, then click the **OK** button.
7. Click the up or down arrows in the Items field to increase or decrease the number of ranges.
8. Enter a value for the first item in the list, in the field to the right of  $-\infty \leq$ .
9. Enter a value for the last item in the list, in the field to the left of  $\leq \infty$ .
10. Click the **Auto Generate Values** button. The remaining values and colors will be filled in.

### ***Changing the Color for a Range***

Use the following procedure to change the color that represents a range of values.

1. Click the colored square next to a range of values. The Color palette appears.
2. Choose a color.
3. Click the **OK** button to close the Color palette.

## Cell Site Layer Properties

A cell-site database contains information about the individual elements (cell, antenna, and channel) that are part of the cell-site configuration. The Cell Site Layer Properties dialog box allows you to select the cell site database and the options for the layer. In the Route Map, the Cell Site layer shows symbols for the cell sites, and identifies the active cell. A vector line is drawn from the active cell to the current position of the vehicle.

**Note:** A cell site database must be available to use this feature. Refer to the Cell Site Editor software's online help for information about creating one.

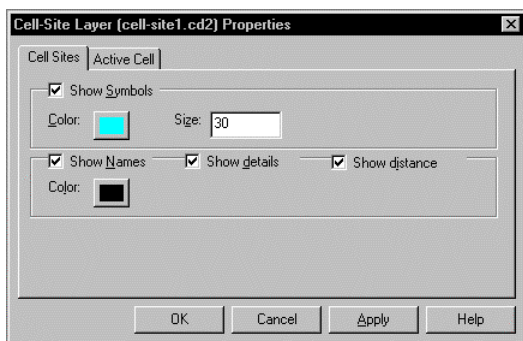

Right-click on the **Cell Site** layer button.  The Cell-Site Layer Properties dialog box appears. Complete the entries on the Cell Sites and Active Cell tabs.

**Figure 26**  
**Cell-Site Layer Properties Dialog Box**



## Cell Sites Tab Properties

**Note:** In previous software releases, the cell site database was selected on this tab. The cell site database selection field has been moved to the Options dialog box. To select the cell site database, refer to the procedure on page 74.

- Enable the Show Symbols check box to display cell site symbols on the map.
- To change the cell site symbol color, follow these steps:
  1. Click the color button next to the check box.  The Color palette appears.
  2. Choose a color for the cell site symbols.
  3. Click the **OK** button.
- Click the Show Names check box to display a cell site's name on the map.
- To change the color of the cell site names, follow these steps:
  1. Click the Color button under the Show Names check box.  The Color palette appears.
  2. Choose a color for the cell site names.
  3. Click the **OK** button.
- Enable the Show Details check box to display the cell site information.
- Enable the Show Distance check box to display the distance from the cell site to the vehicle.

- Click the Active Cell Tab or the **OK** button.



### Active Cell Tab Properties

Click the **Active Cell** tab to bring it to the front. (In the following procedures, refer to page 27 for details about the DFI Selector view.)

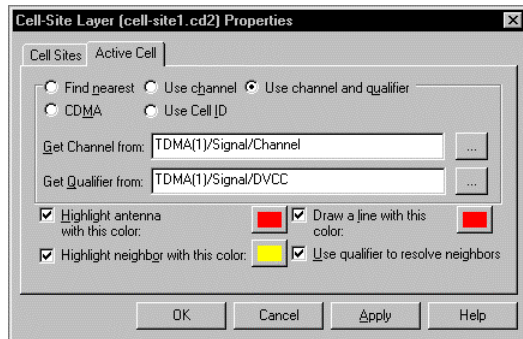
**Figure 27**  
**Active Cell Tab**



Choose one of the following methods for determining the active cell.

- **Find Nearest:** The cell closest to the vehicle is indicated as the active cell.
- **Use Channel:** Click the select button.  The DFI Selector view appears. Choose a channel, then click the **OK** button. The channel is entered into the Get Channel From field.  
Example: For the Channel, click the plus box to expand the Signal frame, then select **Channel**.
- **Use Channel and Qualifier:** Click the select button.  The DFI Selector view appears. Choose a qualifier, then click the **OK** button. The channel is entered into the Get Qualifier From field. Also choose a channel, as described above.  
Example: For the Qualifier, click the plus box to expand the Signal frame, then select **DVCC**.
- **Use Cell ID:** This selection is currently not supported.

### Antenna Color

Use the following procedure to change the color of the antenna symbols.

1. Click the check box for Highlight Antenna with This Color.
2. Click the Color button next to the check box.  The Color palette appears.
3. Choose a color for the antenna.
4. Click the **OK** button to close the Color palette.

### Neighbor Antenna Color

Use the following procedure to select the color of the neighbor antenna symbols.

1. Click the check box for Highlight Neighbor With This Color.
2. Click the Color button next to the check box.  The Color palette appears.
3. Choose a color for the antenna.

4. Click the **OK** button to close the Color palette.

### ***Use Qualifier to Resolve Neighbors***

If you have selected Use Channel and Qualifier to identify the active cell, and have checked the Highlight Neighbor With This Color check box, click the Use Qualifier to Resolve Neighbors check box to use the channel qualifier to identify the neighbor cell sites.

### ***Line Drawn from Antenna Color***

Use the following procedure to change the color of the vector line from the antenna to the current position indicator.

1. Click the check box for Draw Line with This Color.
2. Click the Color button next to the check box.  The Color palette appears.
3. Choose a color for the line drawn from the antenna to the current position indicator.
4. Click the **OK** button to close the Color palette.
5. Click the **OK** button to close the Cell-Site Layer Properties dialog box.

### **Current Position Layer Properties**

Use the following procedure to select the data to be shown at the current position (Position, Speed, and Heading).

1. Right-click on the **Current Position** layer button.  The Current Position Properties dialog box appears.
2. Click the check boxes for the data items that you want to display at the current position.
3. Click the **OK** button to close the dialog box.

### **Grid Layer Properties**

Use the following procedure to change the grid spacing and color.

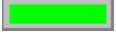
1. Right-click on the Grid layer button.  The Grid Layer Properties dialog box appears.
2. Enter the Distance Between Lines in meters.
3. Click the Color button.  The Color palette appears.
4. Choose a color for the grid.
5. Click the **OK** button to close the Color palette.
6. Click the **OK** button to close the Grid Layer Properties dialog box.

### **Survey Marker Layer Properties**

Survey Marker Properties are selected on the Survey Markers tab of the Options dialog box. Please refer to page 71 for a description of the options.

## Scanner View

To display this view click **View | Scanner**. The Scanner view is a column graph that shows the signal strength (in dBm) for each channel that you have selected. Drag the scroll bar to see different groups of channels. If the legend is not visible during data collection or playback, drag the right border to increase the width of the view. To hide the legend, drag the right border to decrease the width of the view.

**Figure 28**  
Scanner View (Select Visible Series Mode)

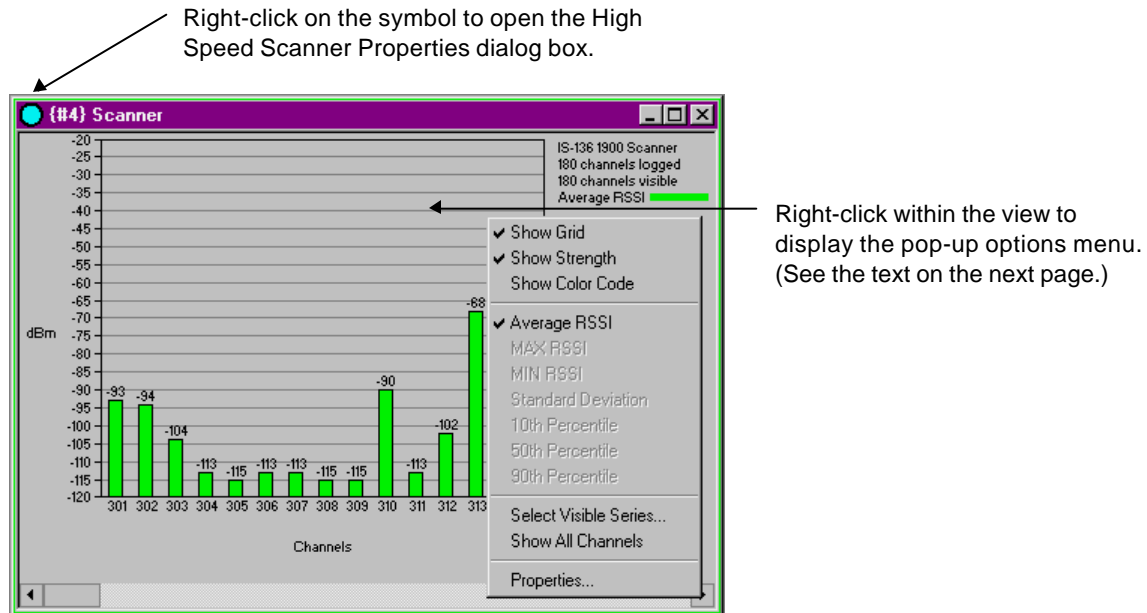

**Note:** You must select the channels that you want to scan in the High Speed Scanner Properties dialog box. To display this dialog box, right-click on the colored symbol in the view's title bar. Refer to *Chapter 5 — Device Configuration* for the procedure.

**Figure 29**  
Scanner View (Show All Channels Mode)

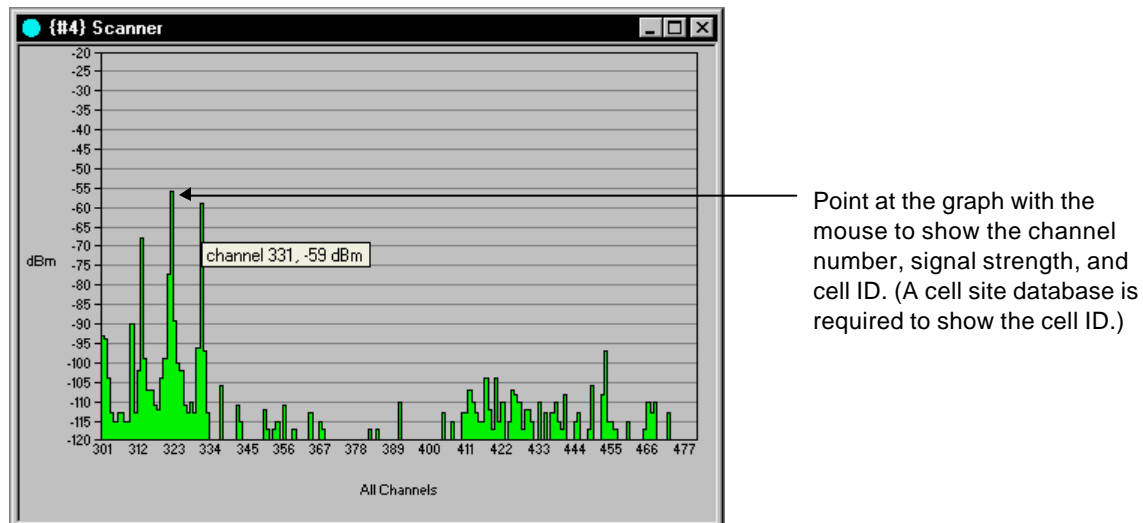

## Configuring the Scanner View

### *Pop-up Options Menu for a TDMA Scanner*

Right-click within the Scanner view to display the pop-up menu that lists the user-configurable options. Click on a menu item to enable or disable it. (A check mark appears when an item is enabled.)

- **Show Grid:** Click this item to show or hide the grid.
- **Show Strength:** Click this item to show the signal strength value above each column. This option is not available when you select Show All Channels.
- **Average RSSI:** You must check this item to display the Average signal strength column.
- Choose one of the following after you begin data collection or playback:
  - **Select Visible Series:** This command is only available if Show All Channels is not checked. Click this command to display the **Select Visible Series** dialog box. This allows you to select the channels to be displayed in this view.
  - **Show All Channels:** Click (to check) this item to display all of the channels selected in the High Speed Scanner Properties dialog box. Move the pointer over the signal strength graph to display the channel number, signal strength, and the cell site name of an individual channel. (A cell site database is required to display the cell ID.)
- **Properties:** Click this item to open the Dimas HSScannerView Properties dialog box. (See page 52.) This allows you to customize the Scanner view. (It is not used to configure the scanner data collection properties.) You can change the bar color, the bar width, and the space between the bars.

### *Pop-up Options Menu for an EAMPS Scanner*

Right-click within the Scanner view to display the pop-up menu that lists the user-configurable options. Click on a menu item to enable or disable it. (A check mark appears when an item is enabled.)

- **Show Grid:** Click this item to show or hide the grid.
- If available, choose one of the following. (Neither option is available when you select Show All Channels.)
  - **Show Strength:** Click this item to show the signal strength value above each column.
  - **Show Color Code:** Click this item to show the SAT value above each column.
- Select one or more of the following Data Modes: Average RSSI, MAX RSSI, MIN RSSI, Standard Deviation, 10th, 50th, 90th Percentiles.

**Note:** If more than one Data Mode is selected, the Show All Channels option will not be available. To show measurements in this view, you must enable the same Data Modes (for logging) in the High Speed Scanner Properties dialog box. (See page 83 for more information.)

- Choose one of the following:
  - **Select Visible Series:** This command is only available after you begin data collection or playback. Click this command to display the **Select Visible Series** dialog box. This allows you to select the channels to be displayed in this view.
  - **Show All Channels:** Click (to check) this item to display all of the channels selected in the High Speed Scanner Properties dialog box. Move the pointer over the signal strength graph to



display the channel number, signal strength, and the cell site name of an individual channel. (A cell site database is required to display the name.)

- **Properties:** Click this item to open the Dimas HSScannerView Properties dialog box. (See page 52.) This allows you to customize the Scanner view. (It is not used to configure the scanner data collection properties.) You can change the bar color, the bar width, and the space between the bars.

### Select Visible Series Dialog Box

This dialog box allows you to select the channels to be displayed. To display it, start data collection or playback, then right-click within the Scanner view, and click **Select Visible Series...** on the pop-up menu that appears. The following sections describe the options.

**Figure 30**  
**Select Visible Series Dialog Box**

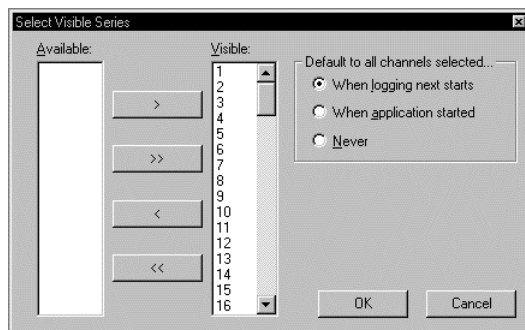

#### Available

This is the list of channels selected in the High Speed Scanner Properties dialog box.

#### Visible

This is the list of channels that will be displayed in the view.

#### Default to All Channels Selected... Section

This section allows you to choose how all of the channels selected in the High Speed Scanner Properties dialog box are entered into the Visible section. The choices are:

- **When Logging Next Starts:** The entire channel list is reloaded for display when you start a data collection test or begin playback of a data file.
- **When Application Started:** The entire channel list is reloaded for display when you start the data collection software.
- **Never:** The channels entered manually (as described below) are stored for display.

#### Adding Channels to the Visible List

- If an available channel is not listed in the Visible section, highlight the channel number in the Available section, then click the right-arrow button.
- To add all of the channels from the Available section to the Visible section, click the double right-arrow button.

### Removing Channels from the Visible List

- Highlight the channel number in the Visible section, then click the left-arrow button.
- To remove all of the channels from the Visible section and move them to the Available section, click the double left-arrow button.

### Closing the Dialog Box

Click the **OK** button to close the dialog box and save the changes.

### *Dimas HSScannerView Properties Dialog Box*

This dialog box allows you to customize the Scanner view. To display it, right-click within the Scanner view. Next, click **Properties...** on the pop-up menu that appears. The following sections describe the options on the four tabs. After you select the options, click the **OK** button to close the dialog box.

**Figure 31**  
**Scanner Properties Dialog Box**

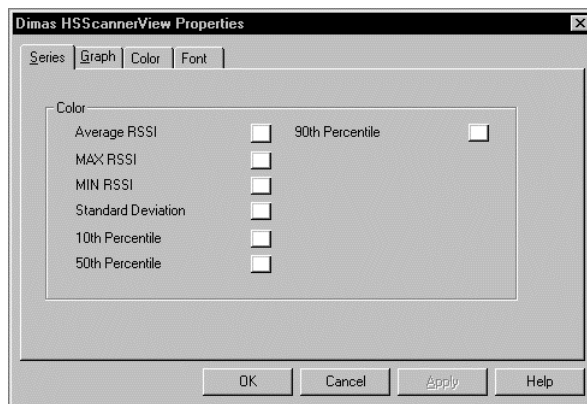

### Series Tab

The Average RSSI color button allows you to select a different color for the columns. (The other buttons only apply to analog scanners.) To change the color, click the color button, then select a color from the Color palette. Click the **OK** button to close the Color dialog box.

### Graph Tab

This tab allows you to select the following graph characteristics:

- **Bar Width:** Select 5 to 15 pixels.
- **Bar Gap:** Select 1 to 10 pixels to separate the bars.
- **Channel Gap:** Select 5 to 15 pixels to separate the channel number indicators.
- **Threshold:** Enter a value, then click the red square and select a color from the palette. Signals that exceed the threshold are displayed in the color chosen.

### Color Tab

You can choose other colors for the background, the foreground, and the grid.

1. Click the button in the Properties section for the property that you want to change.

2. Select a Color Set from the drop-down list. The choices are Standard Colors and Windows System Colors.
3. Choose a color from the Color Palette.
4. Optional: Click the **Edit Custom Color** button, then choose a new color for the button in the Color dialog box, and click the **OK** button to close the Color dialog box.
5. Click the **Apply** button.
6. Click the **OK** button to close the Color dialog box.

### **Font Tab**

You can choose other fonts and character sizes for this view.

1. Choose a font from the Font drop-down list.
2. Choose a size from the Size drop-down list.

### **Closing the Dialog Box**

Click the **OK** button to close the dialog box and save the changes.

## Scanner Table View

To display this view click **View | Scanner Table**. This view displays a table of up to 250 channels and their signal strengths in dBm. Channel numbers to be scanned must be entered on the Scanner Channel tab of the High Speed Scanner Properties dialog box. In the figure below, the “W” in the Style column indicates a normal (Wide) channel.

**Figure 32**  
**Scanner Table View**

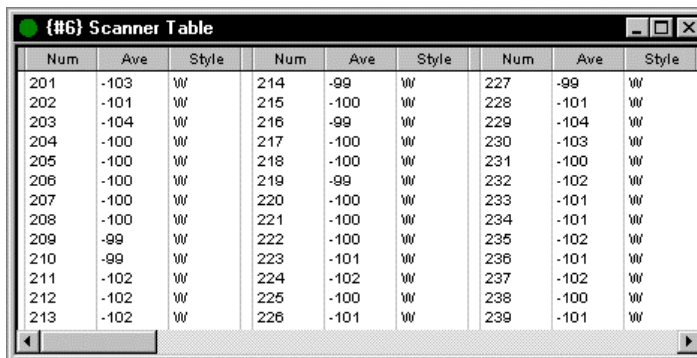

Num	Ave	Style	Num	Ave	Style	Num	Ave	Style
201	-103	W	214	-99	W	227	-99	W
202	-101	W	215	-100	W	228	-101	W
203	-104	W	216	-99	W	229	-104	W
204	-100	W	217	-100	W	230	-103	W
205	-100	W	218	-100	W	231	-100	W
206	-100	W	219	-99	W	232	-102	W
207	-100	W	220	-100	W	233	-101	W
208	-100	W	221	-100	W	234	-101	W
209	-99	W	222	-100	W	235	-102	W
210	-99	W	223	-101	W	236	-101	W
211	-102	W	224	-102	W	237	-102	W
212	-102	W	225	-100	W	238	-100	W
213	-102	W	226	-101	W	239	-101	W

### Scanner Table View Pop-up Menu

Right click within the view to display the pop-up menu. This menu contains the following items:

- **Display Header:** Click (to check) the check box to display the column headings.
- **Display Grid:** Click (to check) the check box to display the grid.
- **Properties:** Click this item to display the Dimas ScanGrid Control Properties dialog box. This allows you to change the colors of the background, foreground, and grid of the view

### Changing the Scanner Table View Colors

1. Right click within the Scanner Table view, then click **Properties**. The Dimas ScanGrid Control Properties dialog box appears.
2. Click the button in the Properties section for the property that you want to change.
3. Select a color set from the drop-down list. The choices are Standard Colors and Windows System Colors.
4. Choose a color from the Color Palette.
5. Optional: Click the **Edit Custom Color** button, then choose a new color for the button in the Color dialog box, and click the **OK** button.
6. Click the **OK** button to close the dialog box and save the changes.

## Call Stats View

An example of the Call Stats view is shown below. The category headings are described on the next page. Statistics can be displayed numerically using Grid View (the default) as shown below, or graphically using Chart View, as shown on the next page.

**Figure 33**  
**Call Stats Grid View**

Category	Value
Technology	IS136 800 Tracker
Label	{#5}
Total	
Good	
Blocked	
Dropped	
No Service	
MPIO	
Progress	
Setup	
Breakdown	

### Grid View Options

Right-click in the category headings section to display the Grid View pull-down menu. The sub-menus are described on the next page.

#### **Label Sub-Menu**

The device label (a name you have selected) and the technology can be shown or hidden. Right-click in the table area, then enable each item individually on the Label sub-menu. Refer to page 25 for information about device labels.

#### **Statistics Sub-Menu**

Statistics can be displayed in the following categories. Right-click in the table area, then enable each item individually on the Statistics sub-menu.

- **Total:** This field indicates the number of calls attempted during the test.
- **Good:** This field indicates the number of calls where no problem was observed.
- **Dropped:** This field indicates the number of calls that ended before the Call Duration timer expired.
- **Blocked:** This field indicates the number of calls where a voice or traffic channel was not assigned within the Call Setup interval specified.
- **No Service:** This field indicates the number of calls attempted where service was unavailable.
- **MPIO:** My Phone Is Off. This indicates the number of calls made to another phone in the data collection system that were not answered. (The phone that was called was not assigned a Voice channel.)
- **Progress:** This field is used for displaying messages. Examples are: Idle, Dialing, Setup, On Call, and Continuous Call. In addition to the messages, seconds remaining are displayed for Idle time,

Setup time, and On Call time. The count value starts with the value entered on the Auto Dialling tab, then it decreases.

- **Setup:** This field indicates the time period from the time the phone number is dialed to the time the call is assigned a Voice channel.
- **Breakdown:** This field indicates the time period from the time the END key is pressed to the time the phone is assigned a Control channel.

### **TQNM Sub-Menu**

**No Comm:** If a call is ended by the software and the phone does not react to the End key command, the next time the software instructs the phone to place a call, it will find it unavailable. The failed attempt is classified as “No Comm”. This is the only TQNM category available for the WALKABOUT.

### **Chart View**

Click the last item in the pop-up menu to switch to Chart View. In this view, the statistics are displayed graphically.

**Figure 34**  
**Call Stats Chart View**

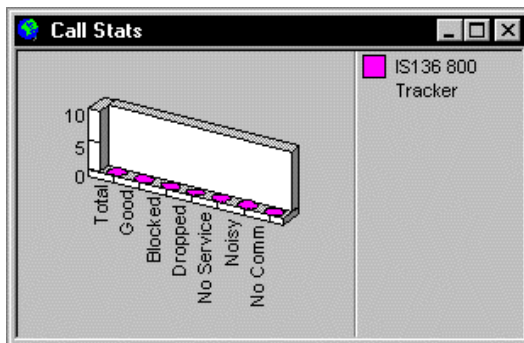

## Chart View Options

The graphic can be shown in 2D or 3D, and 3D properties can be user-configured via the pull-down menu. Right-click within the chart area to display the pull-down menu. The menu contains the following items.

### **Legend**

This menu item allows you to show or hide the legend on the right side, as shown above.

### **Rotate**

Click this menu item to display the 3D View Properties dialog box.

**Figure 35**  
**3D View Properties Dialog Box**

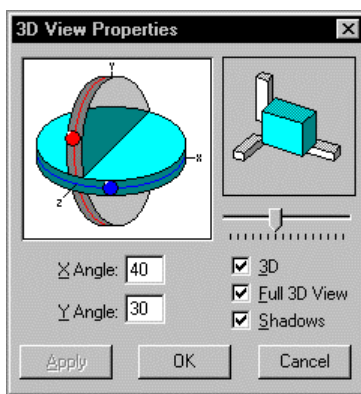

- **3D:** With this box checked, the chart is displayed in 3D. With the box unchecked, the chart is displayed in 2D.
- **Full 3D View:** With this box checked, you can change the chart height, depth, and rotation. With the box unchecked, a predefined chart is displayed.
- **Shadows:** With this box checked, additional gray is added to the chart.
- **X Angle:** Enter a value, or click and drag the red dot in the diagram to change the height of the chart.
- **Y Angle:** Enter a value, or click and drag the blue dot in the diagram to rotate the chart horizontally.
- **Slider:** Click and drag the slider to change the depth of the base.

### **Applying Changes and Closing the Dialog box**

Click the **Apply** button to apply a change. Click the **OK** button to close the dialog box and apply the changes.

### **Grid View**

To switch to the Grid View, right-click in the table area of the Chart View, then click the last item on the pop-up menu.

## Carrier vs Interferer View

This view allows you to select a Carrier signal and an Interferer signal, and graphically display the difference between them in dB. The numeric value is displayed in real time, and a legend is provided to identify the signal pairs. If the legend is not visible after you configure the view, increase the width of the view by dragging the right border.

**Figure 36**  
**Carrier vs Interferer View**

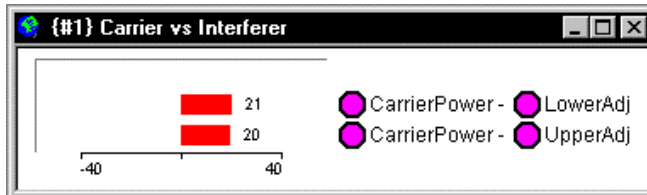

### Options

- You can display the carrier or server vs a designated channel received by the scanner.
- Multiple C to I measurements can be displayed simultaneously.
- The scale is user-definable.

### Carrier vs Interferer Examples

The following are some examples of C to I pairs that can be entered in the Carrier vs Interferer Properties dialog box, described on the next page. (Other combinations of Carrier and Interferer are possible.)

Carrier	Interferer
Carrier Power	Lower Adjacent
Carrier Power	Upper Adjacent
RSSI (full)	N1 RSSI



## Configuring the Carrier vs Interferer View

Before any Carrier and Interferer signal pairs can be displayed, the view must be configured. To configure this view, right-click within it. Next, click the **Properties** button that appears. The configuration options on tabbed pages of the dialog box are described below.

**Figure 37**  
**Carrier vs Interferer Properties Dialog box**

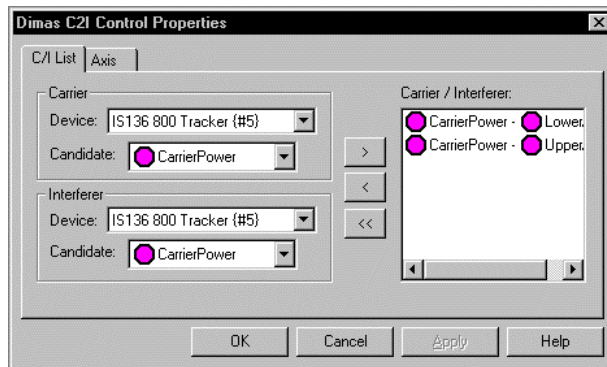

### C/I List Tab

#### Carrier Section

1. Select a Carrier device from the Device drop-down list. Typically, you will select the call tracking phone.
2. Select a Carrier signal from the Candidate drop-down list. Typically, you will select the Carrier Power signal.

#### Interferer Section

1. Select an Interferer device from the Device drop-down list. Typically, you will select the call tracking phone, but you can select the scanner.
2. Select an Interferer signal from the Candidate drop-down list.
  - If you have selected the tracking phone as the Interferer device, typically, you will select an adjacent channel or neighbor signal.
  - If you have selected the scanner as the Interferer device, you can select a specific channel to plot against the Carrier signal.

#### Carrier / Interferer List Box

- To add the Carrier and Interferer signal pair that you have selected above to the Carrier / Interferer list box, click the right-arrow button.
- To delete a Carrier and Interferer signal pair, highlight the pair in the Carrier / Interferer list box, then click the left-arrow button.
- To delete all of the Carrier and Interferer signal pairs, click the double left-arrow button.
- Click the Apply button to add the Carrier / Interferer signal pairs displayed in the list box to the Carrier vs Interferer view.

## **Axis Tab**

### ***Scale Field***

The default is 30 dB, which displays -30 dB to +30 dB on the x-axis of the graph. You can enter another value to increase or decrease the scale.

### **Closing the Dialog box**

Click the **OK** button to exit the dialog box and save the changes.

## Monitor Settings View

The Monitor Settings view is used for configuring alerts. Parameters collected as integer values or messages can be monitored using the criteria that you select. When the criteria are met, either a .wav file can be played, or a marker can be written to the data file and displayed on the Route Map and / or in the Time Chart view. Click **View | Monitor Settings** to open this view.

For parameter and message alerts to be active, the Monitor Settings view must be open, although it can be minimized. If desired, multiple instances of this view can be open at the same time. (Refer to page 69 for this procedure.)

**Figure 38**  
**Monitor View**

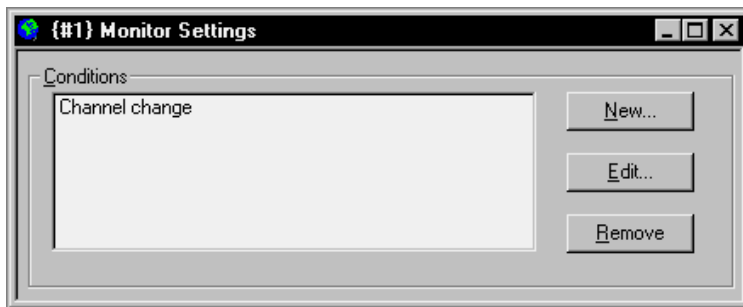

### Examples of Alerts

The following are examples of alerts. The parameters listed are in the Signal frame of the DFI Selector view.

Condition for Alert	Parameter
When the RSSI falls below a user-specified level	RSSI (full)
When the Channel changes	Channel
When Neighbor 1 RSSI goes above a user-specified level	N1RSSI

### Overview of Configuring an Alert

In addition to the Monitor Settings view, there are three dialog boxes that are used in configuring an alert. The following is a summary of the four items involved in configuring an alert.

1. **Monitor Settings View:** This view displays a list of the existing alerts. Click the **New** button to create a new alert. You can also edit or delete an existing alert listed this view. Clicking the **New** button or the **Edit** button will cause the Edit Condition dialog box to open.
2. **Edit Condition dialog box:** This dialog box allows you to choose the parameter(s) and the select the conditions that will cause the alert. Parameters are listed as “Data Streams”, and appear in the Data Stream list in the following format: Device/Frame/Parameter. The Data Stream Candidates dialog box is accessed from this view.
3. **Data Stream Candidates dialog box:** This dialog box acts as a “hold area” for the parameters that can be added to the Edit Condition dialog box. A parameter is added to the list in this dialog box by selecting it from the DFI Selector view.

4. **DFI Selector view:** This view is a tree structure that shows the tracking phone and scanner, and the parameters that are collected for each device. A parameter selected in this view is added to the list in the Data Stream Candidates dialog box.

## Configuring an Alert

### Monitor Settings View

The Monitor Settings view has three command buttons:

- **New:** To add a condition to the Monitor Settings view list, or if no alerts have been created, click the this button. The Edit Condition dialog box opens.
- **Edit:** To make changes to an existing condition, highlight the entry in the Conditions list, then click the this button. The Edit Condition dialog box opens.
- **Remove:** To delete an existing condition, highlight it , then click the this button.

### Edit Condition Dialog Box

This dialog box is used for selecting the conditions that will cause the alert, and the action to be taken when it occurs. Make a selection for each of the following items.

**Figure 39**  
Edit Condition Dialog Box

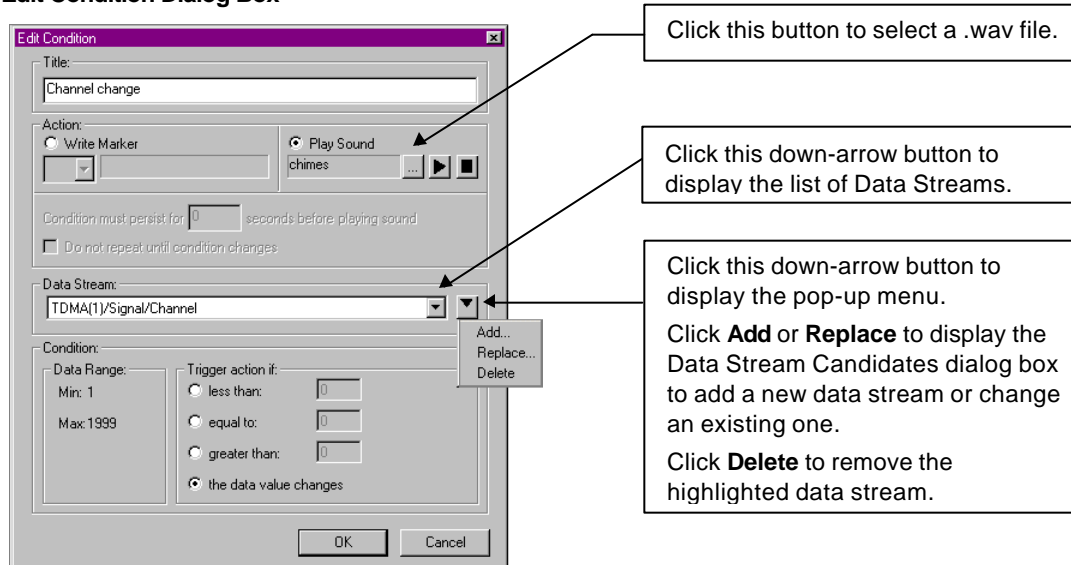

- **Title:** Enter the name that you want to give the alert. (This entry appears in the Monitor Settings view.)
- **Action:** Choose Write Marker or Play Sound.
  - If you choose Write Marker, then also click the down-arrow and choose a marker symbol from the drop-down list. The marker will be written to the data file, and will also be displayed on the Route Map.
  - If you choose Play Sound, then also click the browse button.  The Load Sound File dialog box opens. Choose a .wav file, then click the **Open** button.

- **Condition must persist for:** Enter the time (in seconds) that the condition must continue to cause an alert. No entry is required if you choose “The Data Value Changes” for the Condition. (See the following page.)
- **Do not repeat until condition changes:** Enable the check box to prevent further alerts after the first instance.
- **Data Stream:** Add items to this list using the Data Stream Candidates dialog box. (This procedure is described on the next page.) Only one data stream is required, although the list can contain up to five. The conditions entered in this dialog box apply to the highlighted item. Each item in the list has its own set of criteria. If there are multiple items in the list, all conditions must be met (true) for the alert to be triggered. The list is visible when the list box down-arrow is clicked.

Clicking the down-arrow button next to the list box arrow causes a pop-up menu to appear. (See on the previous page.) The pop-up menu has the following commands:

- **Add:** When you select this command, the Data Stream Candidates dialog box opens.
  - **Replace:** This command is only active if there is a data stream in the list box. Highlight a data stream, then click **Replace** to open the Data Stream Candidates dialog box, as shown on the next page. This allows you to select a different parameter for the Data Stream list.
  - **Delete:** Click this command to delete the highlighted data stream in the list box.
- **Condition:** The range of values is displayed in the **Data Range** section.

Choose one of the following in the **Trigger action if** section:

- **less than:** Enter a value in the text box. The alert is generated when the value is less than the value specified.
- **equal to:** Enter a value in the text box. The alert is generated when the parameter measurement is equal to the value specified.
- **greater than:** Enter a value in the text box. The alert is generated when the value is greater than the value specified.
- **the data value changes:** The alert is generated when the value changes.

**Note:** When a message parameter has been selected, a list of possible messages appears in the Messages list box. Highlight the message(s) that you want to generate the alert. The alert is generated when the selected message(s) changes. You can select multiple messages.

Click the **OK** button to close this dialog box after making the selections.

### Data Stream Candidates Dialog Box

The Data Stream Candidates dialog box is used as a “hold area” or interface between the Data Stream list in the Edit Condition dialog box and the DFI Selector view. (Refer to page 27 for a detailed description of the DFI Selector view.) It holds the names of parameters that can be added to or removed from the Data Stream list.

**Figure 40**  
Data Stream Candidates Dialog Box

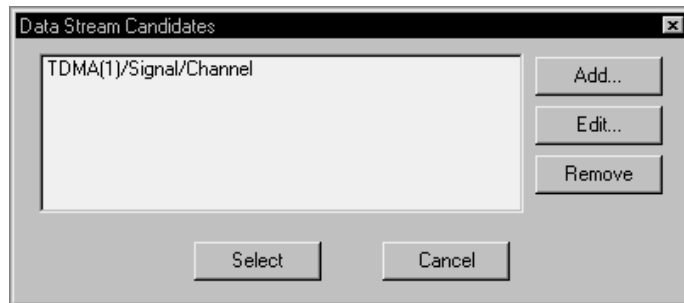

The Data Stream Candidates dialog box has the following buttons:

- **Add:** To add a parameter to the Data Stream Candidates dialog box, click this button. The DFI Selector view opens. Click the plus boxes to expand the tree. Choose a parameter for the device that you are monitoring, then click the **OK** button to close the DFI Selector view. Repeat the process to add another parameter to the list in the Data Stream Candidates dialog box.
- **Edit:** To change a parameter already in Data Stream Candidates dialog box, highlight the parameter in the list, then click this button. The DFI Selector view opens. Click the plus boxes to expand the tree. Choose a different parameter for the device that you are monitoring, then click the **OK** button to close the DFI Selector view.
- **Remove:** To remove a parameter already in Data Stream Candidates dialog box, highlight the item in the list, then click this button.
- **Select:** To add an item to the Data Stream list in the Edit Condition dialog box, highlight the Data Stream in this dialog box, then click **Select**.
- **Cancel:** Click this button to close the dialog box without saving changes.

### Reconfiguring an Existing Alert

Use the following procedure to reconfigure an alert that is already listed in the Monitor Settings view.

1. Highlight the alert that you want to reconfigure.
2. Click the **Edit** button. The Edit Condition dialog box appears.
3. Follow the instructions on page 62.

## Time Chart View

This view can be configured to plot the values of up to six parameters over time. Each parameter can be color-coded and labeled in the legend area of the view. As shown below, you can display event markers, and configure the view with two y-axes, if you want to display parameters that have different value ranges. The scale minimum and maximum values are defined in the Time Chart Properties dialog box. If necessary, multiple instances of this view can be open at the same time. (Refer to page 69 for this procedure.)

Click **View | Time Chart** to open the view. The following procedure describes how to configure the Time Chart view.

**Figure 41**  
**Time Chart View**

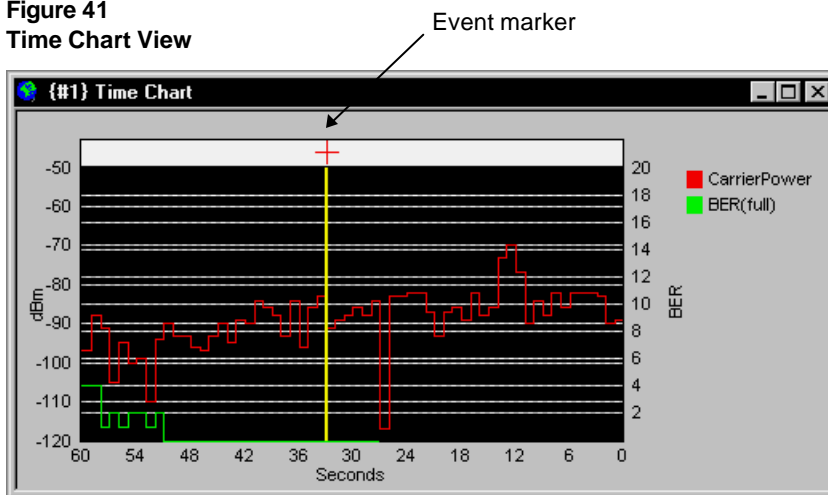

## Time Chart Properties

The Time Chart Properties dialog has four tabbed pages to separate the properties by function. Right-click within the graph area to open the Time Chart Properties dialog box.

**Figure 42**  
**Time Chart Properties Dialog Box**

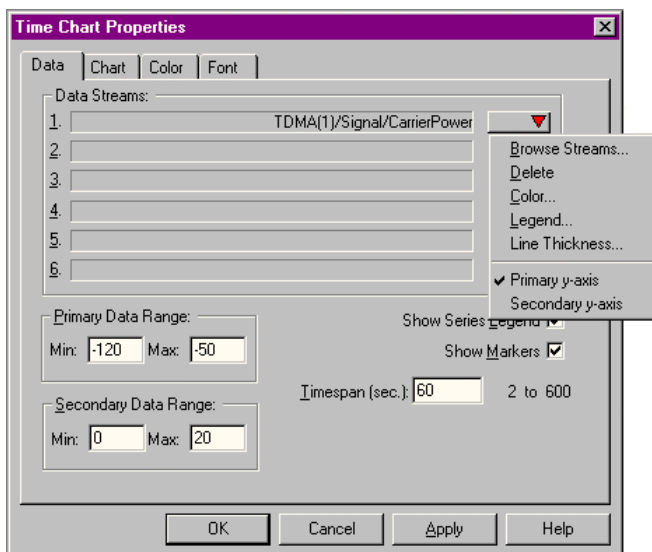

## Data Tab

### Adding a Parameter to the Time Chart

Parameters can be added while a data collection test is running or stopped.

1. Click the down-arrow button  for one of the Data Stream rows. A pop-up menu appears, as shown on the previous page.
2. Click **Browse Streams**. The DFI Selector view opens, showing all of the available parameters. (See page 27 for a detailed description of the DFI Selector view.)
3. Choose the parameter from the Signal frame that you want to monitor. Only parameters reported as integer values are allowed. The following are some examples:

Frame	Parameter	Min	Max
Signal	BER	0	20
Signal	CarrierPower	-120	-50
Signal	TimeAlignment	0	31
Signal	TxPower	0	10

4. Click the **OK** button. The DFI Selector view closes, and the parameter is added to the Data Stream list.
5. Enter the Min and Max values in the Primary Data Range section. (See the examples above.)
6. Click (to check) the Show Series Legend check box to display the legend.
7. Click (to check) the Show Markers check box to display the event markers when they occur.
8. Optional: Enter a new value in the Timespan field to change the resolution. The range is 2-600 seconds. The default is 20 seconds.

To add a second parameter that has the same range of values, repeat steps 1 through 4. To add a parameter that has a different range of values, see *Using the Secondary Y-axis* on the next page.

### Choosing a Color for the Parameter

Use the following procedure to assign a color to a parameter (series) as it is traced. During data collection or playback, a colored square appears in the legend to identify it, if the check box for Show Series Legend is checked.

1. Click the down-arrow button  to display the pop-up menu.
2. Click **Color**. The color palette appears.
3. Choose a color.
4. Click the **OK** button.

### Labeling the Parameter in the Legend

Use the following procedure to assign a label to a parameter. During data collection or playback, the label appears in the legend to identify the parameter, if the check box for Show Series Legend is checked.



1. Click the down-arrow button  to display the pop-up menu.
2. Click **Legend**. The Legend dialog box appears.
3. Enter the name of the parameter.
4. Click the **OK** button.

### **Changing the Line Thickness**

1. Click the down-arrow button  to display the pop-up menu.
2. Click **Line Thickness...** The Series Line Thickness dialog box opens.
3. Select a line thickness.
4. Click the **OK** button.

### **Removing a Parameter from the Time Chart**

1. Click the down-arrow button  to display the pop-up menu.
2. Click **Delete**. The parameter is removed.

### **Using the Secondary Y-axis**

1. Follow the steps in the preceding sections, starting with *Adding a Parameter to the Time Chart*, to add a new data stream.
2. Choose a color for the new parameter.
3. Assign a label to the new parameter.
4. Click the down-arrow button  to display the pop-up menu.
5. Click **Secondary y-axis**.
6. Enter the Min and Max values in the Secondary Data Range text boxes.

**Figure 43**  
**Object Properties Dialog Box with Secondary Y-axis Selected**

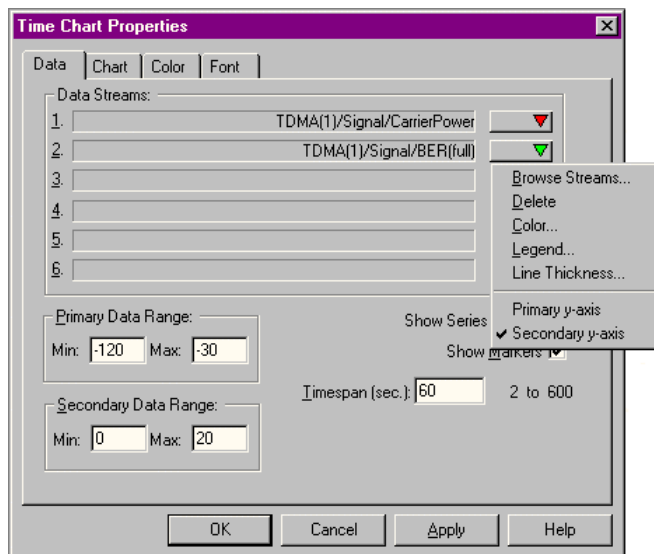

## Chart Tab

The following options are available for configuring the chart properties of the Time Chart view. Default settings are provided. Click the **OK** button or another tab after you make the necessary changes on this page. This tab has three sections: Text, Grid Lines, and Survey Marker Lines.

### *Text*

All text entries are optional. You can enter a chart title, and add labels for the x-axis and the two y-axes.

### *Grid Lines*

The default style is dotted. You can also select dashed or solid lines. Check boxes are provided to display horizontal grid lines, vertical grid lines, or both.

### *Survey Marker Lines*

Six line thickness settings are available. You can also select a solid, dashed, or dotted survey event marker line style.

## Color Tab

The following options are available for configuring the color properties of the Time Chart view (except for the parameter tracing colors). Default colors have been selected. Click the **OK** button or another tab after you make the necessary changes on this page.

### *Properties*

You can change the following colors within the view: BackColor (the area surrounding the chart), ChartColor (the chart background), chart frame, grid lines, label text, marker line, and title. Click on one of the Properties, then select a color from the Color Palette section.

### *Color Set*

You can choose colors from the Windows system colors or from the standard Windows colors.

### *Color Palette*

Choose one of the colors listed for the property that you have selected.

### *Custom Colors*

Clicking the **Edit Custom Colors** button opens the Color palette, that allows you to customize the selected color.

## Font Tab

The following options are available for configuring the font properties of the Time Chart view. Defaults are provided. Click the **OK** button or another tab after you make the necessary changes on this page.

### *Properties*

Choose Label or Title, then select the Font, Size, and Effects.

**Font**

Select a character font from the list.

**Size**

Select a point size from the list.

**Effects**

Choose the desired effects (Bold, Italic, Underline, Strikeout).

**Closing the Time Chart Properties Dialog Box**

Click the **OK** button to close the dialog box and save the changes.

**Selecting Multiple Views**

You can display multiple Call Stats, Carrier vs Interferer, Monitor, and Time Chart views, if needed.

**Adding a View**

1. Click **View** | <view name> to display the first instance of the view.
2. Click **View** | <same view name>. The View - <view name> dialog box appears.
3. Click the **New** button. Another view number is added to the list box.
4. Click the **Rename** button to customize the name in the title bar of the new view.
5. Click the **OK** button to close the dialog box, and add the view to the main window.

**Removing a View**

To remove a view from the list box, highlight the view's name, then click the **Delete** button. You can also remove a view from the main window by clicking the **Close** button in the title bar. 

## Navigation View

If your system is equipped with a navigator, the Navigation view displays the direction, speed, altitude, satellites visible, satellites tracked, and GPS mode. Each item must be enabled for collection in the MultiMode Navigation Properties dialog box, as described below.

**Figure 44**  
Navigation View

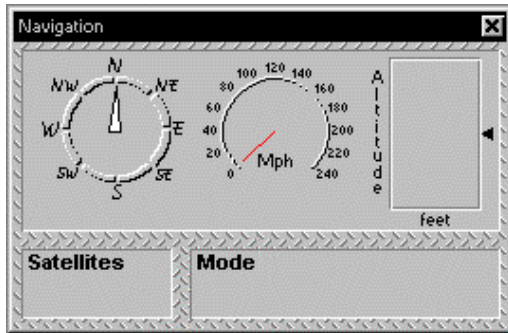

**Note:** The following are limitations of this view:

- Clarion Navigator: Only Position and Heading are displayed in this view.
- ETAK GPS PCMCIA Card: No data from this navigator is displayed in this view.
- Garmin GPS II Plus: Satellites Visible is not displayed, and the Heading indicator does not update during a drive test.
- SAFCO MultiMode Navigator: The Navigation Mode is not displayed.
- Trimble Placer: Satellites Visible is not displayed in this view.

## MultiMode Navigation Properties

To access the MultiMode Navigation Properties dialog box, follow these steps:

1. Click **View | System Setup** to open the System Setup view. (See page 22 for an example.)
2. Right-click on **Navigator**. A pop-up menu appears.
3. Click **Properties**. The dialog box opens.
4. Enable the items that you want to display, then click the **OK** button.

**Figure 45**  
MultiMode Navigation Properties Dialog Box

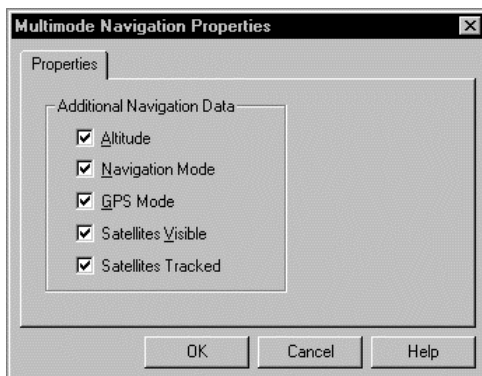

## Options Dialog Box

### Survey Markers Tab

Use the following procedure to change the Route Map survey maker symbols. If OPAS32 is installed on the same computer, symbols can be shared between the two applications. Symbols are found in the SAFCO\Shared\Symbols folder.

1. Click **View | Options**. The Options dialog box opens.

**Figure 46**  
**Options Dialog Box: Survey Markers Tab**

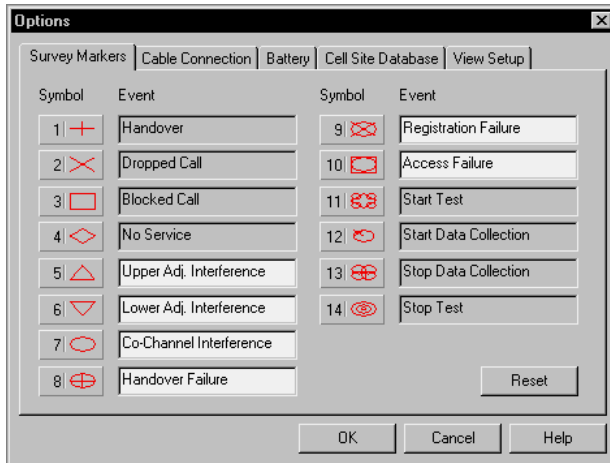

2. Click the marker symbol that you want to change. The select Survey Marker Symbol dialog box appears.
3. Select a new symbol.
4. Click the **OK** button to close the Survey Marker Symbol dialog box.
5. Enter a name in the text box next to the symbol to give it a label.
6. Click the **OK** button to close the Options dialog box.

## Cable Connection Tab



This tab is used for configuring cable connection status alerts. An audio alert (.wav file) can be played during a data collection test when there is a loss of communication with the tracking phone, scanner, or the navigator.

Use the following procedure to configure this feature.

1. Click **View | Options...**
2. Click the Cable Connection tab. The following dialog box appears.

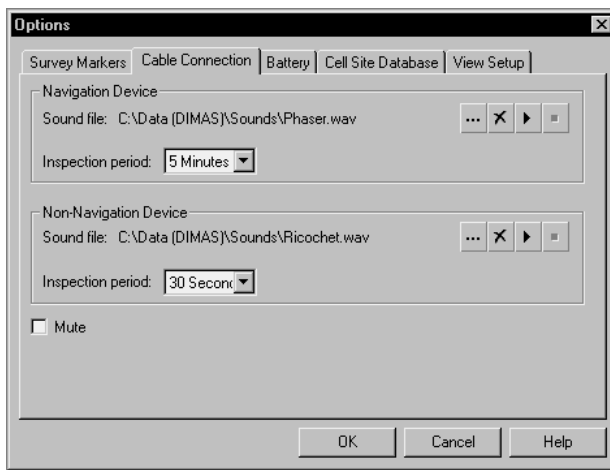
**Figure 47**  
**Options Dialog Box: Cable Connection Tab**



3. Choose an Inspection Period (the time interval between checks for a position update) for the Navigation connection. The choices are N/A, 10 seconds, 30 seconds, 1 minute, and 5 minutes.
4. Click the select button for the Navigation sound file.  The Open dialog box appears.
5. Locate and select a .wav file, then click the **OK** button.
6. Choose an Inspection Period (the time interval between checks for a position update) for the Navigation connection. The choices are N/A, 10 seconds, 30 seconds, 1 minute, and 5 minutes.
7. Click the Select button for the Non-Navigation sound file.  The Open dialog box appears.
8. Locate and select a .wav file, then click the **OK** button.
9. Click the **OK** button to close the dialog box.

## Battery Tab

This tab is used for configuring the Low Battery Alert. An audio alert (.wav file) can be played during a data collection test when the WALKABOUT's battery discharges to a critical level. (This does not apply to in-vehicle systems powered by the vehicle's battery.)

Use the following procedure to configure this feature.

1. Click **View | Options...**
2. Click the **Battery** tab. The following dialog box opens.

**Figure 48**  
**Options Dialog Box: Battery Tab**

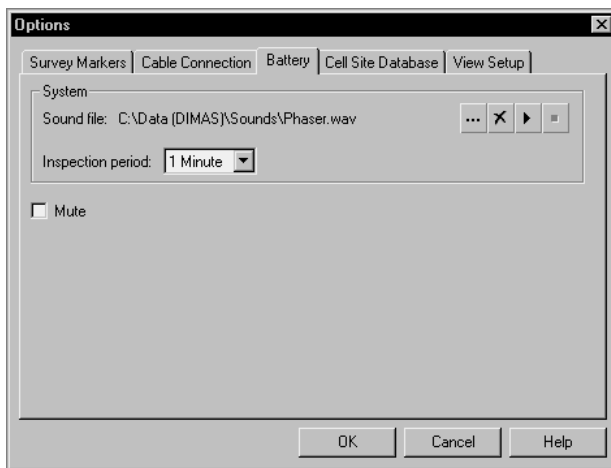

3. Choose an Inspection Period (the time interval between checks for a position update) for the Navigation connection. The choices are N/A, 10 seconds, 30 seconds, 1 minute, and 5 minutes.
4. Click the select button for the Navigation sound file.  The Open dialog box appears.
5. Locate and select a .wav file, then click the **OK** button.

## Cell Site Database Tab

This tab is used for selecting the cell site database. A cell site database allows the names of serving and neighbor cell sites to be displayed on the Route Map and in the Signal Parameters view. Use the following procedure to select the database.

1. Click **View | Options...**
2. Click the **Cell Site Database** tab. The following dialog box appears.

**Figure 49**  
**Options Dialog Box: Cell Site Database Tab**

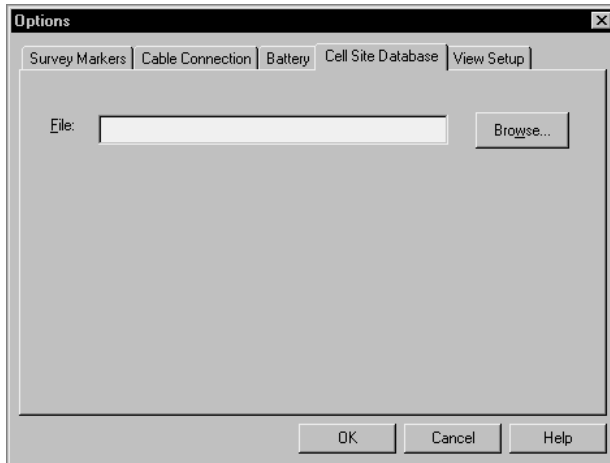

3. Click the **Browse** button. The Open dialog box appears.
4. Locate and highlight the Cell Site database file.
5. Click the **Open** button to close the Open dialog box.
6. Click the **OK** button to close the Options dialog box.

## View Setup Tab

The View Setup tab only applies to iDEN phones and scanners.

## TQNM Tab

This tabbed page (not shown in the previous figure) has one check box:

- Freeze when logging is paused, e.g. hang up calls.**

It causes one of the following actions when you click the **Pause** button during a test:

- Checked: Hang up the phone immediately. No further calls are placed.
- Unchecked: Continue the test without logging data. Calls continue to be placed according to the parameter settings on the Autodialling tab.

Choose one option, then click **OK**, or select another Options tab.

In either case, views that normally display data are not updated, however, the vehicle position on the Routemap view is updated.



## The Next Step

Refer to *Chapter 5 — Device Configuration* for information on how to select the data collection options for the tracking phone and scanner.



## Chapter 5 — Device Configuration

### Introduction

After you configure the display, the next step is to select the data collection options. Options include selecting the phone number to automatically dial, selecting the parameters that you want to collect, and selecting the messages you want to collect. Option selection is referred to as *device configuration*, and must be done before you can start a data collection survey. Options are selected in the Properties dialog box for each device.

### Properties Dialog Box

The following instructions describe how to open the Properties dialog box for a device. This dialog box has multiple tabbed pages with related data collection options. Descriptions of each tabbed page follow.

**Tip:** Detailed information about the Properties page you are configuring can also be found by clicking the **Help** button within the dialog box. See page 81 for instructions on how to use the Contents and the Index of the online help system.

To display the Properties dialog box for a tracking phone or scanner, use one of the following methods:

#### Method 1

1. Click the title bar of any view for the device that you want to configure. (You cannot use the Call Stats, Carrier vs Interferer, Monitor, or Time Chart views to open the Properties dialog box.)
2. Right-click on the colored symbol located on the left side of the title bar. The Properties dialog box for the device opens.

**Figure 50**  
**Title Bar** Right-click on the symbol to open the Properties dialog box.



#### Method 2

1. Press the **F5** key, or on the main menu bar, click **View | System Setup**. The System Setup view opens.
2. Right-click on the tracker or scanner that you want to select options for. A pop-up menu appears. (The Navigation view properties are described on page 70.)
3. Click the **Properties** command. The Properties dialog box for the device opens.

Select the data collection options on each of the tabs, using the following instructions as a guide. After all of the options have been selected, click the **OK** button to close the dialog box. The properties are saved, and the system is ready to perform a survey.

## Configuring the TDMA (IS-136) Tracker

Display the IS136 Properties dialog box, as described on the previous page. As shown below, the dialog box contains four tabbed pages. Click a tab to bring the page into view. Refer to the following sections for details on selecting the data collection options on each tab.

**Figure 51**  
**IS-136 Properties Dialog Box**

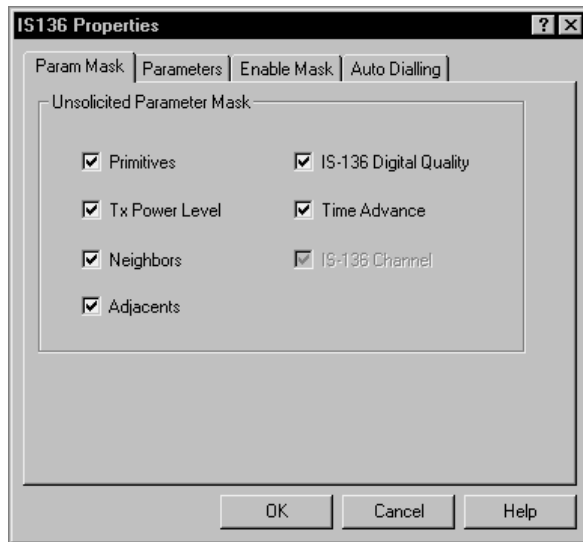

### Param Mask Tab

The following items are on this tab:

- **Primitives:** Click the check box to enable collection of Common Air Interface messages.
- **Parameters:** Click the check box for each parameter to be collected. (Refer to the table below.) Enabling parameters on the Param Mask tab affects the data that appears in the views.

Enable this option...	To display this parameter...	In this IS-136 view
Primitives	CAI Messages	CAI Messages
Tx Power Level	Transmit Power Level	IS136 Tracker
Neighbors	Neighbor Channels, RSSI	Neighbors RSSI
Adjacents	Upper and Lower Adjacent Channel RSSI values	IS136 Tracker
IS-136 Digital Quality	Bit Error Rate	IS136 Tracker
Time Advance	Time Advance (TA)	IS136 Tracker
IS-136 Channel (Enabled by default)	Channel, DVCC, Call State, Channel Type, Time Slot (TS), DTX, SDCC1, SDCC2	IS136 Tracker

## Parameters Tab

Click the Parameters tab to bring it into view. The following items are on this tab:

- **Time, Distance:** The Time and Distance entries on this tab determine how frequently samples are taken. Enter a value in the Time and / or the Distance fields. (1 second is typical.) If a value is entered for both Time and Distance, the trigger that occurs first will reset the counter for both triggers.

If an entry is made in the Distance field, feet or meters will be indicated. The unit of measure is determined by the computer's regional settings.

- **Unsolicited Message Only:** Click the check box to override the time or distance recording interval trigger, and trigger collection on unsolicited messages. If this option is enabled, a map showing the data and signal strength locations cannot be produced.

## Enable Mask Tab

Click the Enable Mask tab to bring it into view. Click the check box for each type of primitive (Common Air Interface) message to be collected. The choices are:

- Analog Channel Overhead Messages
- Analog Channel Order Messages
- Traffic Channel Messages
- User Interface Messages
- DCCH Messages

## Auto Dialling Tab

Click the Auto Dialling tab to bring it into view. You must check either the Autodial or Auto Answer check box. (Check Autodial for a single-phone system.)

- **Autodial:** Click the check box to enable automatic dialling to the number in the Call Number text box during a data collection test.
- **Call Statistics:** Click the check box to collect Call Statistics.
- **Auto Answer:** Click the check box to enable the Auto Answer feature. The Auto Answer feature allows you to use one tracking phone to call a second tracking phone. (Two WALKABOUT systems are required to use the Auto Answer feature.) If you use this feature, one tracking phone should have Autodial enabled, and the other tracking phone should have Auto Answer enabled.
- **Immediate Dial:** If the Immediate Dial check box is checked and the current call is dropped, a new call will be initiated after the specified Idle Time. If it is not checked and the current call is dropped, a new call will be initiated after the specified Idle Time plus the remaining Call Duration time.
- **Call Duration:** Enter call length in seconds. 90 seconds is typical. Enter 0 for a continuous call.
- **Idle Time:** Enter the time to allow between calls. 20 seconds is typical.
- **Call Setup:** Enter the time allowed to set up the call. 20 seconds is typical.

- **Call Number:** Enter the phone number to be dialed.
- **Mode:** The Nokia 2160, 6120, and 6160 dual-mode phones can be forced to operate in a single mode. Choose an operating mode from the Mode drop-down list. The choices are: Normal, AMPS Only, IS-136 Only and IS-54B Only. The new mode setting remains in effect until the phone is powered off. Upon the next power-up, the phone returns to its normal dual mode operation.

---

**Note:** The first call will always be in Digital mode, regardless of the mode choice. You must make more than one call to allow the phone to switch to Analog mode. However, the network may not always allow the phone to switch to Analog mode when digital service is available.

---

### **Saving Properties**

Click the **OK** button to close the IS-136 Properties dialog box, and save all of the selections and entries made on the tabs. They are retained for future sessions.

To close the dialog box without saving changes, click the **Cancel** button.

## Configuring the Scanner

Display the High Speed Scanner Properties dialog box, as described on page 77. As shown below, the dialog box contains three tabbed pages. Click a tab to bring the page into view. Refer to the following sections for details on selecting the data collection options for each tabbed page.

**Figure 52**  
**High Speed Scanner Properties Dialog Box**

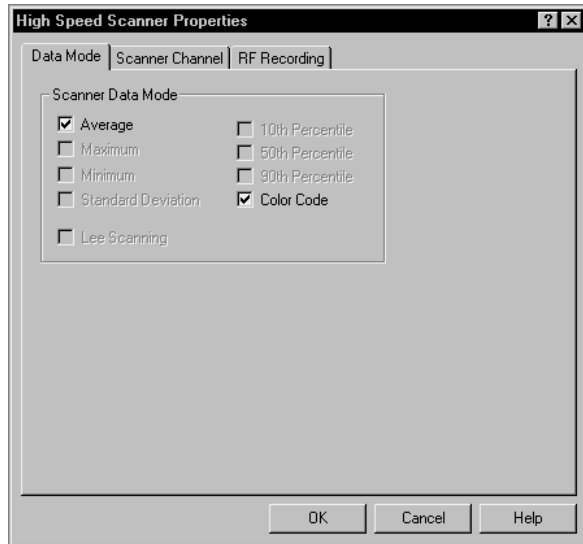

### Data Mode Tab

As data is collected, it continuously moves through the sample buffer. Depending on the scanner technology, the check boxes on this tab allow you to select one or more categories of data.

#### *TDMA Scanner*

Average and Color Code are the only selections available for TDMA scanners. The Average check box must be enabled. Enable Color Code to log the channel qualifier.

#### *EAMPS Scanner*

The following Data Modes are only available for analog scanners. You must enable at least one data mode. (Average is usually selected.)

- **Average:** Record the average value of the samples.
- **Maximum:** Record the highest value of the samples.
- **Minimum:** Record the lowest value of the samples.
- **Standard Deviation:** Record the standard deviation value of the samples.
- **10th Percentile:** Record the value at the 10th percentile of the samples.
- **50th Percentile:** Record the value at the 50th percentile of the samples.
- **90th Percentile:** Record the value at the 90th percentile of the samples.
- **Color Code:** Record the SAT value.

## Scanner Channel Tab

The entries on this tab determine which channels are included in the scan list. The fields that appear on this tab are described below.

**Figure 53**  
**Scanner Channel Tab**

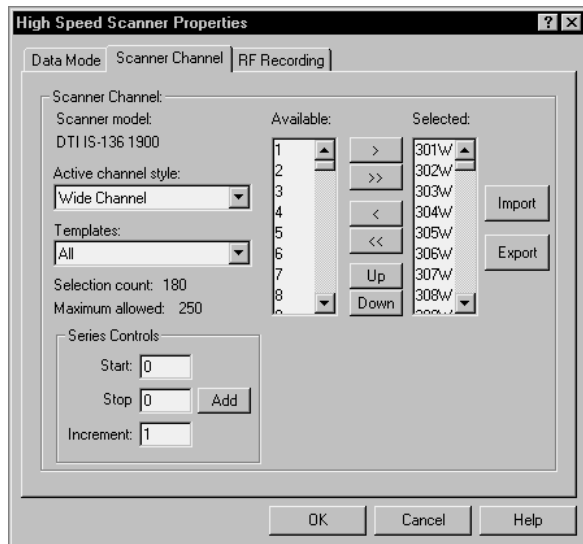

### **Scanner Model**

The technology for the scanner is automatically displayed in the Scanner model field. This is determined when the devices are selected.

### **Active Channel Style**

The only valid Active Channel Style for a TDMA or an EAMPS scanner is Wide Channel.

### **Available Channel List**

This is the list of channels that can be added to the Selected channel list. It is based on the template you have selected.

### **Selected Channel List**

This is the list of channels that will be scanned during a data collection test.

### **Adding Channels to the Scan List**

Use the following procedure to add channels to the Selected (scan) list. You can select up to 250 channels.

1. Press and hold the **Ctrl** key while you click the channel numbers in the Available list. (Channels can also be selected individually, without using the **Ctrl** key.)
2. Click the right-arrow (>) button. The channels are added to the Selected channel list.



### Moving and Removing Channels

- Click the **Up** and **Down** buttons to move the highlighted channel's position in the Selected list.
- To remove a channel from the Selected list, highlight the unwanted channel, then click the left-arrow (<) button.

### Series Controls

Use the following procedure to add a series of channels to the Selected scan list.

1. Enter the first channel of the series in the Start field.
2. Enter the last channel of the series in the Stop field.
3. Enter the channel series increment value in the Increment field.
4. Click the **Add** button.

### Using Custom Scan Lists

You can create custom scan lists that can be distributed to other users, by using the Import and Export buttons. You can also create and / or edit a scan list using Microsoft® Excel.

#### Exporting a Scan List

1. Add the desired channels to the Selected scan list as described previously.
2. Click the **Export** button.
3. Enter a file name in the dialog box.
4. Click the **Save** button. The list of channels in the Selected list is saved as a Channel Plan File (\*.cpf).

#### Importing a Scan List

1. Click the **Import** button.
2. Locate the \*.cpf file that has been saved or obtained from another source, or the \*.csv file created using Excel. (This is described on page 86.)
3. Click the **Open** button.

### RF Recording Tab

The entries on this tab determine how frequently samples are taken. Enter a value in the Time and / or the Distance fields. (1 second is typical.) If a value is entered for both Time and Distance, the trigger that occurs first will reset the counter for both triggers.

If an entry is made in the Distance field, feet or meters will be indicated. The unit of measure is determined by the computer's regional settings.

### Saving Properties

Click the **OK** button to close the High Speed Scanner Properties dialog box, and save all of the selections and entries made on the tabs. They are retained for future sessions.

To close the dialog box without saving changes, click the **Cancel** button.

---

**Note:** If you have made any changes on the Data Mode tab, you must also save the current configuration before you begin a data collection test. After you close the Properties dialog box, click **File | Save** to save the current configuration as an .spf file. If the configuration has not already been saved, the Save As dialog box will appear.

---

## Using Multiple Test Plans

For added flexibility, you can create multiple test plans with different data collection options and screen views. Test plan configuration options are stored in the SAFCO Plan File (\*.spf).

### Creating a New .SPF File

After you configure the screen views and select the data collection options, use the following procedure to create a new .SPF file.

1. Click **File | Save As**. The Save As dialog box appears.
2. Open the WALKABOUT\Views folder.
3. Enter a file name.
4. Click the **Save** button. The settings are saved in the new .spf file.

### Opening an .SPF File

1. Click **File | Open | Views**.
2. Select (highlight) the .spf file that you have saved.
3. Click the **Open** button.

## Editing a Scan List

You can edit a scan list created by the data collection software using Microsoft® Excel. Follow the procedure described previously for exporting the scan list. This will create a \*.cpf file for the scan list you are currently using.

### Opening an Existing \*.cpf File in Excel

1. Click **File | Open**, and using “All Files” for the Files of Type option, locate and select the \*.cpf file.
2. Click the **Open** button. The Text Import Wizard will be displayed.
3. In Step 1 of the Wizard, select the Delimited option, then click **Next**.
4. In Step 2 of the Wizard, select only the Comma check box option, then click **Finish**.

### Editing the File

The \*.cpf file is formatted as follows: The first column contains the scanner model number, which is used by the data collection software. The second column contains the channel number. The third column contains the abbreviation for the Channel Style.

The following is an example of three rows of the file as they would appear in Excel for a TDMA 1900 scanner. The channel numbers are 333, 334, and 335, and the channel style is W (for Wide channel).

Model	Channel	Style
13	333	W
13	334	W
13	335	W

Add or delete channels as needed. Be sure to include the scanner model and channel style abbreviation. A maximum of 250 channels can be entered in the scan list. Please note the following scanner specifications:

Technology	Model	Channel Range
EAMPS	1	1 through 799, 991 through 1023
TDMA (IS-136) 800	12	1 through 799, 991 through 1023
TDMA (IS-136) 1900	13	1 through 1999

- The only valid channel style for TDMA and EAMPS scanners is W (for Wide.)

### Saving the Edited File

After you have completed the edit of the channel scan list, click **File | Save**. The file can be reopened for editing as described above.

## Creating a Scan List

You can also create a custom scan list without using the data collection software. A Channel Plan File template named **cpf\_template.csv** is included with the data collection software, which contains the format described previously, under Editing the File. It is located in the same folder that contains **dimas.exe**, the data collection executable program. We recommend that you use this template, however if you open a blank Excel spreadsheet using the default template, you must use the keywords **Model** in cell A1, **Channel** in cell B1, and **Style** in cell C1, using the text case as shown. (Bold text is not required.)

### Saving the File

After you have entered the Model, Channel, and Style for each row of the spreadsheet (noting the limitations on the previous page), click **File | Save As**. For the Save as Type option, select CSV (Comma Delimited). The file can be reopened for editing as a \*.csv file.

## The Next Step

Refer to *Chapter 6 — Data Collection* for information on how to perform a data collection test (survey).

## Chapter 6 — Data Collection

### Survey Types

Depending on the equipment ordered, the WALKABOUT system can be used for three types of surveys:

- **In-building Survey:** With the portable battery-powered WALKABOUT system, you walk the survey route inside of the building while collecting cellular data. Using a bitmap image (.bmp file) of the floor plan for the building, you click your position directly on the Route Map to provide the navigation data.
- **Paced Mode Survey:** With the portable battery-powered WALKABOUT system, you walk the survey route inside or outside of a building while collecting cellular data. In this mode, you do not need a bitmap image (.bmp file) of the floor plan for the building. Navigation is accomplished by first plotting a starting point within the blank Route Map view, then recording the number of paces and direction walked in a dialog box while you collect data.
- **Survey using a Navigator:** With the WALKABOUT system installed in a vehicle, you drive the survey route while collecting cellular data. Positional information is provided by a navigator or a GPS PCMCIA card. If you plan to use the Route Map to show your position, you must provide a bitmap image (.bmp), a street map (.map), or a MapInfo map (.mif) of the area being surveyed. The data collected is geodetically-referenced, whether or not you use the Route Map.

The survey route and signal measurements can be tracked in the Route Map view. Refer to *Chapter 4 — Views* for a description of the Route Map, and to the remainder of this chapter for complete data collection procedures.

### Status Bar

#### Battery Icon

The battery icon changes color to indicate the level of its charge. Green indicates a full charge, yellow indicates a 2/3 charge, and red indicates that the battery has discharged to a critical level. For a system with a scanner, the WALKABOUT battery will last approximately 4 hours. For a system without a scanner, the WALKABOUT battery will last approximately 5 hours.

#### Signal Status

If the data flow from any device is lost for the period specified in the Options dialog box, a flashing  $\emptyset$  appears between the globe and the PC icons, as shown below. (Refer to page 72 for information about the Options dialog box and configuring connection status alerts.)

Figure 54  
Connection Status Icon with Lost Signal



## Performing an In-building Survey

### Introduction

This section describes how to perform a data collection survey within a building. A bitmap image (.bmp) of the survey area is required for the Route Map view. (If you do not have a .bmp file, refer to *Performing a Paced Mode Survey* on page 91.)







Buttons used to perform commands are located on two separate toolbars. Buttons on the main toolbar are used for starting, pausing, and ending a data collection test. Buttons in the Route Map view control functions related to the Route Map and walking.

The following items should be completed before you begin the survey.

- Plan the survey route that you are going to walk before you start the test.
- Charge all batteries, if necessary.
- Connect the system components. (Refer to page 5 for details.)
- Power up the computer, tracking phone, and the WALKABOUT. (Refer to the procedure on page 11.)
- Start the WALKABOUT software. (Refer to the procedure on page 13.)
- Verify that the In Building Navigator check box is selected in the System Setup view. (If this view is not visible, press the **F5** key.)
- Display and configure the In Building Route Map view. Enable the layers that you want displayed. (Refer to the procedure starting on page 40.)
- Select and arrange the data views for display.
- Configure the data collection options for the tracking phone and the scanner. Options are selected in the Properties dialog box for each device.





### Enabling Layers in the Route Map

The following buttons are used to show or hide the individual layers. For a complete description of the Route Map toolbar buttons, refer to pages 36 through 38.

Button	Name	Action
	Map Picture Layer	Click to show or hide the bitmap image of the floor plan or map.
	User Notes	Click to show or hide the user notes.
	Survey Markers	Click to show or hide the survey markers.
	Grid	Show the reference grid.
	Current Position	Show the current position indicator.
	Signal Layer	Click the buttons for the data layers that you want to display. After a Signal layer has been configured, you can point at the button, and its signal name is displayed.

## Performing the Test

The buttons used for an in-building survey are shown in the following procedure. For a complete description of the main toolbar buttons, refer to page 14. For a complete description of the Route Map toolbar buttons, refer to pages 36 through 38.

1.  Click the **Start Logging** button on the main toolbar. The Create Log File dialog box appears.
2. If you have created a folder for data files, open the folder.
3. Enter a name for the data file in the File Name field of the dialog box.
4. Click the **Save** button. The WALKABOUT dialog box appears.
5. Click your starting position on the Route Map.
6.  Click the **Walking / Not Walking** button on the Route Map toolbar.
7. Begin walking the route that you have planned.
8. During the survey, add survey markers and operator notes during the test as required. (Refer to the sections that follow.)
9. Choose a point on the map where you are either going to change direction or stop walking.
10.  When you arrive at the point on the map that you have chosen, click the **Update position** button on the Route Map toolbar.
11. Continue walking in the new direction.
12. Repeat Steps 9 through 11 while you continue the survey.
13.  After you have clicked the **Update position** icon to update your final position, click the **Stop** button on the main toolbar.
14. Click **Yes** in response to the dialog box that follows. The data that you have collected is saved as an .sd5 file.

---

**Note:** If you want to stop walking and continuously collect data at one point, click the Walking / Not Walking icon. Click it again when you continue walking.

---

## Pausing and Resuming Data Collection



Use the following procedure during an in-building data collection survey if you want to stop data collection at one point, then resume data collection at another point without collecting data in between.

1. When you get to the point where you want to pause data collection, click the point on the map.
2.  Click the **Pause** button on the main toolbar.

---

**Note:** While data collection is paused, no data is written to disk, however, the Route Map is updated with new position information. Position updates while data collection is paused are indicated by dots, instead of the usual letters or question marks.

---

3. Click **OK** in response to the dialog box that appears.
4.  Click the **Update position** button on the Route Map toolbar.
5. Walk to the point where you want to resume data collection.
6. Click your new position on the map.
7.  Click the **Update position** button a second time.
8. Click the **Resume** button in the dialog box that appears, then continue with the survey.

## User Notes

Use the following procedure to add a User Note to the Route Map view and to the data file during a survey. To show the notes on the Route Map, click the **User Notes** button. 

1. Press the **F2** key or click **Actions | Insert User Note**. The User Notes dialog box appears.
2. Type in the text for the note.
3. Click the **Add** button. The note is added to the data file, and the dialog box closes.

## Survey Markers

Use the following procedure to add a Survey Marker to the Route Map view and to the data file during a survey. To show the markers on the Route Map, click the **Survey Markers** button. 

1. Press the spacebar or click **Actions | Survey Markers**. The Survey Markers dialog box appears.
2. Click a **Marker** button. The marker is added to the data file, and the dialog box closes.

## Post Processing

The .SD5 data file is ready for post-processing. You can either:

- Play the survey back on the computer. (Refer to the procedure on page 97.)
- Use the file as input to the OPAS32 software for analysis.
- Export the file in another format. (Refer to the procedure on page 99.)



## Performing a Paced Mode Survey

### Introduction





Paced mode can be used when you do not have a bitmap image of the area (inside or outside of a building) where you want to perform a data collection survey. However, you must know the latitude / longitude of your starting point to use this mode.

This section describes how to perform a data collection survey within a building. The following items should be completed before you begin the survey.

- Plan the survey route that you are going to walk before you start the test.
- Determine the latitude and longitude of one corner of the survey area.
- Determine the length of your stride.
- Charge all batteries, if necessary.
- Connect the system components. (Refer to page 5 for details.)
- Power up the computer, tracking phone, and the WALKABOUT. (Refer to the procedure on page 11.)
- Start the WALKABOUT software. (Refer to the procedure on page 13.)
- Verify that the In Building Navigator check box is selected in the System Setup view. (If this view is not visible, press the **F5** key.)
- Display and configure the In Building Route Map view. (For Paced mode, a bitmap image of the survey area is not necessary.)
- Select and arrange the data views for display.
- Configure the data collection options for the tracking phone and the scanner. Options are selected in the Properties dialog box for each device.





### Enabling Layers in the Route Map

The following buttons are used to show or hide the individual layers. For a complete description of the Route Map toolbar buttons, refer to pages 36 through 38.

Button	Name	Action
	User Notes	Click to show or hide the user notes.
	Survey Markers	Click to show or hide the survey markers.
	Grid	Show the reference grid.
	Current Position	Show the current position indicator.
	Signal Layer	Click the buttons for the data layers that you want to display. After a Signal layer has been configured, you can point at the button, and its signal name is displayed.

## Performing the Test

The buttons used for an in-building survey are shown in the following procedure. For a complete description of the main toolbar buttons, refer to page 14. For a complete description of the Route Map toolbar buttons, refer to pages 36 through 38.

1.  Click the **Start logging** button on the main toolbar. The Create Log File dialog box appears.
2. If you have created a folder for data files, open the folder.
3. Enter a name for the data file in the **File name** field of the dialog box.
4. Click the **Save** button. The WALKABOUT dialog box appears, prompting you to click your position on the map.
5. Click **OK** to close the dialog box.
6. Click your starting position within the Route Map view map area. (This area will be blank, since no map was specified in the Map Picture Properties dialog box.)
7.  Click the **Walking / Not Walking** button.
8.  Click the **Paced Mode** button. The In-building Navigation dialog box appears. (See Figure 55 on the next page.)
9. Click **Relative to Map** if it is not already selected.
10. Drag the compass pointer to the direction that you are going to walk.
11. Enter the Length of Pace (length of your stride) in 0.1 centimeters. For example, enter 500 for a 1/2 meter stride.
12. Begin walking the survey route that you have planned.
13. During the survey, add survey markers and user notes as required. (Refer to the sections on the next page.)
14. When you are about to change direction, enter the Number of Paces you have made.
15. Click the **Walk** button. Your position is updated.
16. Drag the compass pointer to the direction that you are going to walk.
17. Continue walking in the new direction.
18. Repeat Steps 14 through 17 while you continue walking the survey route.
19. After you have arrived at your final destination:
  - Enter the Number of Paces.
  - Click the **Walk** button.
20.  Click the **Stop** button on the main toolbar.
21. Click **Yes** in response to the dialog box that follows. The data that you have collected is saved as an .sd5 file.

**Figure 55**  
**In-Building Navigation Dialog Box**

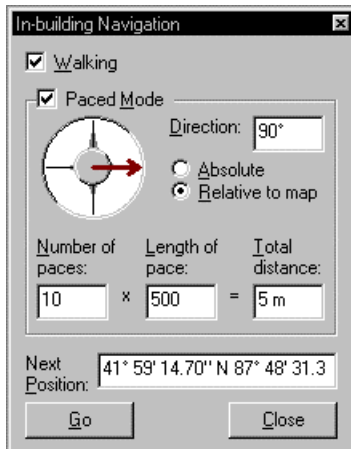

## User Notes

Use the following procedure to add a User Note to the Route Map view and to the data file during a survey. To show the notes on the Route Map, click the **User Notes** button. 

1. Press the **F2** key or click **Actions | Insert User Note**. The User Notes dialog box appears.
2. Type in the text for the note.
3. Click the **Add** button. The note is added to the data file, and the dialog box closes.

## Survey Markers

Use the following procedure to add a Survey Marker to the Route Map view and to the data file during a survey. To show the markers on the Route Map, click the **Survey Markers** button. 

1. Press the spacebar or click **Actions | Survey Markers**. The Survey Markers dialog box appears.
2. Click a **Marker** button. The marker is added to the data file, and the dialog box closes.

## Post Processing

The .SD5 data file is ready for post-processing. You can either:

- Play the survey back on the computer. (Refer to the procedure on page 97.)
- Use the file as input to the OPAS32 software for analysis.
- Export the file in another format. (Refer to the procedure on page 99.)

## Performing an In-Vehicle Survey









### Introduction

A WALKABOUT system installed in a vehicle is equipped with a SAFCO MultiMode, Trimble Placer or Clarion Navigator, which provides positional information. The following items should be completed before you begin the survey.

- Plan the survey route that you are going to drive before you start the test.
- Charge tracking phone and computer batteries, if necessary.
- Connect the system components. (Refer to page 5 in this manual, and to the navigator installation manual for details.)
- Power up the computer, tracking phone, the WALKABOUT, and the navigator. (Refer to the procedure on page 11.)
- Start the WALKABOUT software. (Refer to the procedure on page 13.)
- Verify that the navigator check box is selected in the System Setup view. (If this view is not visible, press the **F5** key.)
- Select and arrange the data views for display.
- Optional: Display and configure the Route Map view. Enable the layers that you want displayed. (The navigator provides the software with navigation data regardless of whether or not the Route Map view is open. Refer to the procedure starting on page 40 if you plan to display the Route Map.)
- Configure the data collection options for the tracking phone and the scanner. Options are selected in the Properties dialog box for each device.

## Enabling Layers in the Route Map

The following buttons are used to show or hide the individual layers. For a complete description of the Route Map toolbar buttons, refer to pages 36 through 38.

Button	Name	Action
	Map Picture Layer	Click to show or hide the bitmap image of the floor plan or map. <b>Note:</b> If this layer is enabled, do not enable the Street Map layer.
	Street Map Layer	Show the selected Street Map when the test or playback begins. <b>Note:</b> If this layer is enabled, do not enable the Map Picture layer.
	Cell-Site Layer	Show the names of the cells. A vector line from the active cell to the current position is drawn. You must select a cell-site database if you are showing this layer. (This is described on page 46.)
	User Notes	Click to show or hide the user notes.
	Survey Markers	Click to show or hide the survey markers.
	Grid	Show the reference grid.
	Current Position	Show the current position indicator.
	Signal Layer	Click the buttons for the data layers that you want to display. After a Signal layer has been configured, you can point at the button, and its signal name is displayed.



## Performing the Test

The buttons used for an in-vehicle survey are shown in the following procedure. For a complete description of the main toolbar buttons, refer to page 14. For a complete description of the Route Map toolbar buttons, refer to pages 36 through 38.

---

**Important!** If your system is equipped with a SAFCO Navigator Plus, the vehicle must be moved while the Navigator Plus is powered on before you start the test. To avoid getting a navigation error, power up the system (including the navigator), move the vehicle a short distance, stop the vehicle, then start the test as described below.

---

1.  Click the **Start logging** button on the main toolbar. The Create Log File dialog box appears.
2. If you have created a folder for data files, open the folder.
3. Enter a name for the data file in the **File name** field of the dialog box.
4. Click the **Save** button.
5. Begin driving the route that you have planned.
6. During the survey, add survey markers and user notes as required.
7. If, during the survey you want to pause (momentarily stop) data collection:
  -  Click the **Pause** button on the main toolbar.
  - Click **OK** in the dialog box that appears. While data collection is paused, no data is written to disk, however, the Route Map is updated with new position information. Position updates while data collection is paused are indicated by dots, instead of the usual letters or question marks.
  - To resume data collection, click the **Resume** button in the Walkabout is Paused dialog box.
8.  After you have arrived at your final destination, click the **Stop** button on the Playback toolbar.
9. Click **Yes** in response to the dialog box that follows. The data that you have collected is saved as an .sd5 file.

## User Notes

Use the following procedure to add a User Note to the Route Map view and to the data file during a survey. To show the notes on the Route Map, click the **User Notes** button. 

1. Press the **F2** key or click **Actions | Insert User Note**. The User Notes dialog box appears.
2. Type in the text for the note.
3. Click the **Add** button. The note is added to the data file, and the dialog box closes.

## Survey Markers

Use the following procedure to add a Survey Marker to the Route Map view and to the data file during a survey. To show the markers on the Route Map, click the **Survey Markers** button. 

1. Press the spacebar or click **Actions | Survey Markers**. The Survey Markers dialog box appears.
2. Click a **Marker** button. The marker is added to the data file, and the dialog box closes.

### Post Processing

The .SD5 data file is ready for post-processing. You can either:

- Play the survey back on the computer. (Refer to the procedure on page 97.)
- Use the file as input to the OPAS32 software for analysis.
- Export the file in another format. (Refer to the procedure on page 99.)

### Replaying a Data File

This section describes how to replay the survey data. The following are features of the playback function:

- The playback speed can be increased and decreased.
- The playback direction can be reversed.
- Playback can be paused.
- The Time Bar slider can be dragged to any point in the data file.
- Playback will stop automatically at the end of the file.
- Playback can be stopped without reopening the file to replay it again.

### Replaying Data During a Survey

While you are collecting data, you can review data that has already been collected.

1. Drag the Time Bar slider to the point where you want to begin reviewing data. While the left mouse button is depressed, the timestamp of where you are in the data file is displayed.
2. Release the left mouse button. Playback begins, and a right-arrow button is displayed on the Time Bar. 
3. Click the right-arrow button (shown above) to return to the real-time display of data.

### Replaying the From the Current Survey

 To replay a survey you have just completed, click the **Replay** button. Playback in the forward direction begins.

### Replaying a Data File from a Previous Survey







To replay a survey from a previous session, follow these steps:

1. Click **File | Open**. The Open dialog box appears.
2. Locate the .sd5 data file.
3. Click the **Open** button.
4. Select and arrange the data views.
5. Configure the Route Map view, if needed.

6.  Click the **Replay** button. Playback in the forward direction begins.

### Main Toolbar Buttons — Playback Mode

The following buttons control the playback of a data file.

Icon	Name	Action
	Stop	Click to stop the replay of a data file
	Pause	Click to pause replay of a data file. Click a second time to continue.
	Fast Reverse Replay	Click to increase the reverse playback rate. Each click increases the speed, from 2 to 7 times normal. Click the <b>Reverse Replay</b> button to return to normal speed.
	Reverse Replay	Click to reverse the replay of a data file. The file must be playing back in the forward direction to use this function. When reverse replaying at a higher than normal rate, click this button to return to normal speed.
	Replay	Click to initiate playback (replay) of the current data file. To replay a data file from a previous data collection test, first click <b>File   Open</b> , then select the .sd5 data file. When replaying at a higher than normal rate, click this button to return to normal speed.
	Fast Replay	Click to increase the playback rate. Each click increases the speed, from 2 to 7 times normal. Click the <b>Replay</b> button to return to normal speed.



## Exporting a Data File

Use the following procedure to export an .sd5 data file in one of two formats. The choices are Comma-delimited (\*.csv) and Tab-delimited (\*.txt).

1. Click **File | Export...** The Save As dialog box appears.
2. In the Save As Type drop-down list, choose a file type.
3. Open the folder that you want to save the file in.
4. Click the **Save** button.

### About MapInfo Files

When you export a file in MapInfo format (\*.mif), two files for each frame of data collected for each device are created. One is a .mif file, and the other is a .mid file. The default prefix for the files created is the file name of the original .sd5 data file. The prefix is followed by the device technology, the frame name, and finally, the extension. The MapInfo software requires both the .mif and the .mid files to be in the same directory.

**Example:** Exporting a file named TDMA data.sd5 will produce many files, including:

- TDMA data TDMA Signal.mif
- TDMA data TDMA Signal.mid
- TDMA data Analog Scanner Strongest Scanning RSSI.mif
- TDMA data Analog Scanner Strongest Scanning RSSI.mid

As shown above, the naming convention is: <Original file name> <Device> <Frame> <File type>

## Exiting the WALKABOUT Software

Click **File | Exit** to properly exit the software. The display and device configurations are saved in the SAFCO Plan File (.spf). The next time you start the WALKABOUT software, the display will initialize as it was for the last session.

## Powering the System Down

1. Press the **⏻** (Off / On) Power switch on the WALKABOUT phone interface to turn the system off.
2. Press the **PWR** button on the tracking phone to turn it off.
3. Click **Start | Shutdown** to power the computer off.



---

## Appendix A — FAQs

---

### Frequently Asked Questions

The following are common questions asked about the WALKABOUT system.

**Question # 1:** When I run a data collection test, I get a high percentage of calls classified as "Blocked". What should I check?

**Answer:** Assuming you are in good coverage area, please check the following:

- Verify that the phone is powered On.
- Verify that in the System Setup view, the check box for the device is checked.
- Make sure that the phone battery is fully charged before you begin a survey. A fully charged battery is necessary to obtain accurate measurements, maintain optimum phone performance, and ensure that the system is working correctly. The WALKABOUT should not be used to charge the battery during a test.
- Verify that the computer's battery is fully charged. The adapter connected to the lighter socket should not be used to charge the battery during a test, because the additional load on the electrical system can degrade system performance.

**Question # 2:** How long will the battery in the WALKABOUT last while I'm performing a survey?

**Answer:** Approximately 4 hours, for a system equipped with a scanner. For a system without a scanner, the battery will last approximately 5 hours.

**Question # 3:** Why doesn't the phone retain the volume setting from the last time I used it?

**Answer:** After you set the volume level, you must power the phone off using its Power key to store the setting.

**Question # 4:** Is it OK for me to upgrade to Internet Explorer 5.0?

**Answer:** If you install Internet Explorer 5.0, when you are prompted to update the ActiveX Controls, click **No**. The updated ActiveX controls are not compatible with the data collection software.

**Question #5:** How do I access FAQ section of the SAFCO web site?

**Answer:**

1. Set up an account so that you can access the Secure Client Services area. (This is described on page x.)
2. The next time you log onto the Internet (after you set up an account), go to the following URL: <http://www.safco.com/support/secure.html>.
3. Click on **Login**, then enter your user name and password.
4. On the Customer Support Secure Client Services page, click on WALKABOUT.
5. On the Customer Support WALKABOUT page, click on FAQs.

**Question # 6:** I sometimes see unexpected behavior from the data collection software. What causes this?

**Answer:** Your computer might have been turned off or lost power with Windows 95 still running. When this happens, Windows files become temporarily corrupt. Run scandisk to clean up the corrupt Windows files, if it does not run automatically with your version of Windows 95.

# Index

- 3D View Properties (Call Stats chart view), 57
- Active channel style, 82
- Audio alerts
  - Connection status, 72, 87
  - Low battery, 73
  - Parameter monitoring, 61
  - Reconfiguring, 64
- Audio monitoring kit, 9
- Autodial number, 80
- Battery
  - Charge level icon, 17, 87
  - Charging, 4
  - Configuring the low battery alert, 73
  - Usable time during a survey, 87
- Cable connections
  - Garmin GPS, 10
  - Portable WALKABOUT system, 5
- Call statistics, enabling, 79
- Carrier vs Interferer Properties, 59
- Cell site database, selecting, 74
- Cell site name, 33, 50, 51
- Charging the battery, 4
- Connection status alert, configuring, 72
- Connection status icon, 17, 87
- Customer Support locations, ix
- Data collection options, 77, 87
- Data collection test
  - In building, 88
  - In-vehicle, 94
  - Paced mode, 91
  - Pausing in-building, 90
  - Pausing in-vehicle, 96
  - Replaying, 97
- Data replay, 97
- Device
  - About dialog box, 25
  - Configuration, 77
  - Enabling, 22
  - Selection, 21
- DFI Selector view, 27
- Diagram
  - Portable system cable connections, 6
  - WALKABOUT front panel, in-vehicle, 6
  - WALKABOUT front panel, original, 5
  - WALKABOUT side view, 6
- Display
  - Example, 13
  - Menus, 15
  - Selecting views, 27
  - Status Bar, 17
  - Time Bar, 16
  - Toolbar, 14
- Edit Condition dialog box, 62
- ETAK GPS PCMCIA card, 10, 22
- Exchanging phones, 11
- Exiting the software, 99
- Exporting data, 99
- Frequently asked questions, 101
- Garmin GPS, 10
- Getting started, 1
- iDEN channel number format, selecting, 74
- In-building navigation dialog box, 93
- Installation
  - Battery, 3
  - Parts list, 3
  - WALKABOUT software, 2
- IS-136 Tracker Properties
  - Auto Dialling tab, 79
  - Enable Mask tab, 79
  - Param Mask tab, 78
  - Parameters tab, 79
  - Saving, 80
- LED, CPU, 11
- Low battery alarm, 73
- MapInfo map, 42
- Menus, 15
- Monitor view, 61
- Multiple views, selecting, 69
- My phone is off (MPIO), 55
- Navigator selection, 22
- Online help, using, 18
- Options dialog box
  - Battery tab, 73
  - Cable Connection tab, 72
  - Cell Site Database tab, 74
  - Survey Markers tab, 71
  - TQNM tab, 74
  - View Setup tab, 74
- Parts list, 3
- Playing back collected data, 97
- Post processing, 90, 93, 97
- Power-up, 11
- Properties
  - Dialog box description, 77
  - High Speed Scanner, 81
  - IS-136 tracker, 78
  - Navigation view, 70
- Repair and return procedure, xi
- Replaying collected data, 97
- Requirements, computer, vii
- Reviewing the system configuration, 23
- Route Map
  - Button bar, 36
  - Cell-site database layer properties, 46
  - Cell-site layer vector line, 48
  - Configuration, 40

- Current Position buttons, 37
- Current Position properties, 48
- In-building survey buttons, 38
- Introduction, 35
- Layer buttons, 38
- Map (.bmp), 40
- Map (street), 41
- MapInfo maps, 42
- Other features, 39
- Signal color scheme, 44
- Signal layer properties, 43
- Street Map properties, 41
- Zoom buttons, 37
- SAFCO Plan File, 84, 99
- Saving the system configuration, 23
- Scan list
  - Adding and removing channels, 82
  - Creating with Excel, 86
  - Editing with Excel, 85
  - Importing and exporting, 83
- Scanner Properties
  - Active channel style, 82
  - Adding a series of channels, 83
  - Data Mode tab, 81
  - RF Recording tab, 83
  - Saving, 83
  - Scanner Channel tab, 82
- Scanner Table view, 54
- Scanner view
  - Description, 49
  - Properties dialog, 52
  - Pull-down menu, 50
  - Select Visible Series dialog, 51
- Secure Client Services, x
- Specifications, viii
- Starting the WALKABOUT software, 13
- Street map, 41
- Survey markers, adding, 90, 93, 96
- Survey markers, configuring, 71
- Survey types, 87
- System
  - Configuration, 21
  - Power-down, 99
  - Power-up, 11
- System Setup view, 21
- Time Chart Properties dialog box, 65
- Time Chart view
  - Adding a parameter, 66
  - Removing a parameter, 67
  - Secondary y-axis, 67
- Toolbar
  - Main, 14
  - Route Map, 36
- User notes, adding, 90, 93, 96
- Views
  - CAI Messages, 28
  - Call Stats chart view, 56
  - Call Stats grid view, 55
  - Carrier vs Interferer, 58
  - DFI Selector, 27
  - IS-136 Tracker, 33
  - Monitor view, 61
  - Navigation, 70
  - Neighbor RSSI, 31
  - Neighbor Time, 32
  - Route Map, 35
  - Scanner Table, 54
  - Time Chart, 65
- WALKABOUT display, 13
- Warranty information, xi
- Web site, SAFCO, x